



DRIVEN BY POSSIBILITY™



SEE **GATES.COM** FOR ADDITIONAL
PRODUCTS FROM GATES

CUSTOMER EXPERIENCE TEAM
+48767235200
inforequest@gates.com

GATES.COM
E2/50244

GATES QUICK-LOK™



SEE THE BENEFITS OF STAYING CONNECTED

The manufacturer reserve the right to amend details where necessary.
© Gates 2023 - Printed in Belgium

STRICT CRITERIA NEED A SOLID SOLUTION

With machines becoming more compact and power intensive, designing and manufacturing hydraulic platforms for a worldwide market is a difficult challenge.

That's because environmental controls aimed at preventing hydraulic leaks are becoming more stringent, while manufacturers are demanding greater production line output. With existing threaded technology, meeting all these strict criteria in an efficient way isn't easy. That's where Gates® Quick-Lok™ comes in.

**SAVE TIME, LOWER COSTS
AND REDUCE THE AMOUNT
OF RE-WORK AND NUMBER
OF WARRANTY CLAIMS.**

THE BENEFITS OF GATES QUICK-LOK

A family of threadless hydraulic couplings and adaptors designed to be leak-free and incorporate quick-to-connect technology, Gates Quick-Lok helps you save time, lower costs and reduce the amount of re-work and number of warranty claims.

SECTORS



CONSTRUCTION



AGRICULTURE



TRUCKS AND BUSES



FORESTRY



HYDRAULIC MANUFACTURING

CONNECTORS

THREADLESS OR THREADED?

THREADED CONNECTIONS – BE AWARE OF THE LIMITATIONS...



Time it takes to assemble and torque a connection into place



Equipment and skill required to properly install



Lack of any visual indication that the correct amount of torque has been applied



Inherent lack of complete process control can extend the time spent re-working, raise costs, as well as increasing the risk of further leaks and costly warranty claims

So, if you want to have full control over your production process and/or reduce all possible errors that may occur, threadless connections should be your first option.

LEAK-FREE DESIGN



By examining the sealing interface between port, adaptor, and assembly to identify potential leak paths, we developed the Gates Quick-Lok coupling family. Quick-Lok incorporates a patented, leak-free design that's suited for a wide range of applications. Ruling out any kind of variation in the process of connecting hose assemblies to ports, with Quick-Lok the 100% leak free connection is made with a tactile feedback or audible click.

PEACE OF MIND COMES STANDARD



Quick-Lok eliminates any chance that the connection will become loose, or that a leak path will be caused by vibration, over torquing or incorrect coupling selection. But the benefits don't end there...

- Installation process is error-proof because it's easy to verify that a connection has been made
- Quick-Lok couplings are tamper-proof and cannot be connected by mistake with other quick-connect products
- Eliminates risks related specifically to threaded connections – once in place, the assembly can neither be disconnected inadvertently, nor released under pressure



**QUICK-LOK CONNECTORS
ARE PRODUCED FROM
HARDENED STEEL AND
MACHINED TO EXTREMELY
HIGH TOLERANCE.**

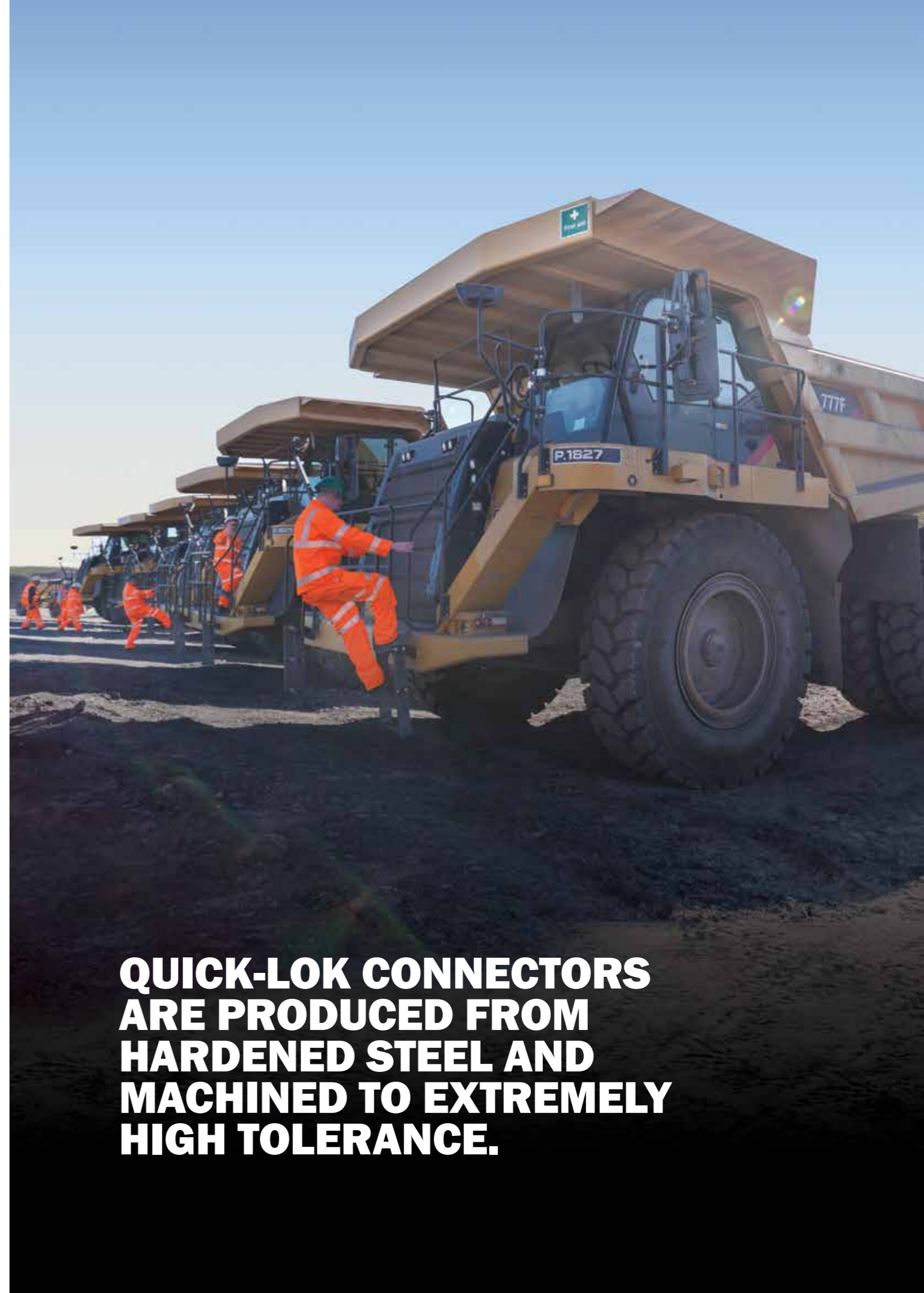

A PROVEN TRACK RECORD

////////////////////////////////////

We manufacture connections to ensure the highest integrity in port-to-port solutions. How? Quick-Lok connectors are produced from hardened steel and machined to extremely high tolerances. They have undergone rigorous testing under actual and simulated field conditions to confirm their strength and sealing ability. The Quick-Lok coupling family is proven to stand up to impulse loads, side loads, flex conditions, vibration, temperature extremes and vacuum conditions.

TESTED, PROTECTED, SELECTED

- Quick-Lok has been tested to ensure that the push-in force is high enough to provide positive feedback that a connection has been made, but low enough to allow easy assembly on the line
- In terms of corrosion resistance properties, all Quick-Lok couplings and adaptors are protected with our chromium 6 free TuffCoat™ plating, showing a red corrosion resistance of at least 400 hours
- That's why Quick-Lok couplings have been embraced by Original Equipment Manufacturers (OEM) around the world.

LOWERING TOTAL COST OF OWNERSHIP

Threadless connectors have developed a reputation as expensive niche products for limited applications. Gates have changed this with the introduction of Quick-Lok assemblies, which are able to replace threaded couplings in a wide range of applications. Our research has shown that by reducing installation and warranty costs, a Quick-Lok assembly solution can dramatically lower total OEM cost of ownership over a comparable threaded assembly.

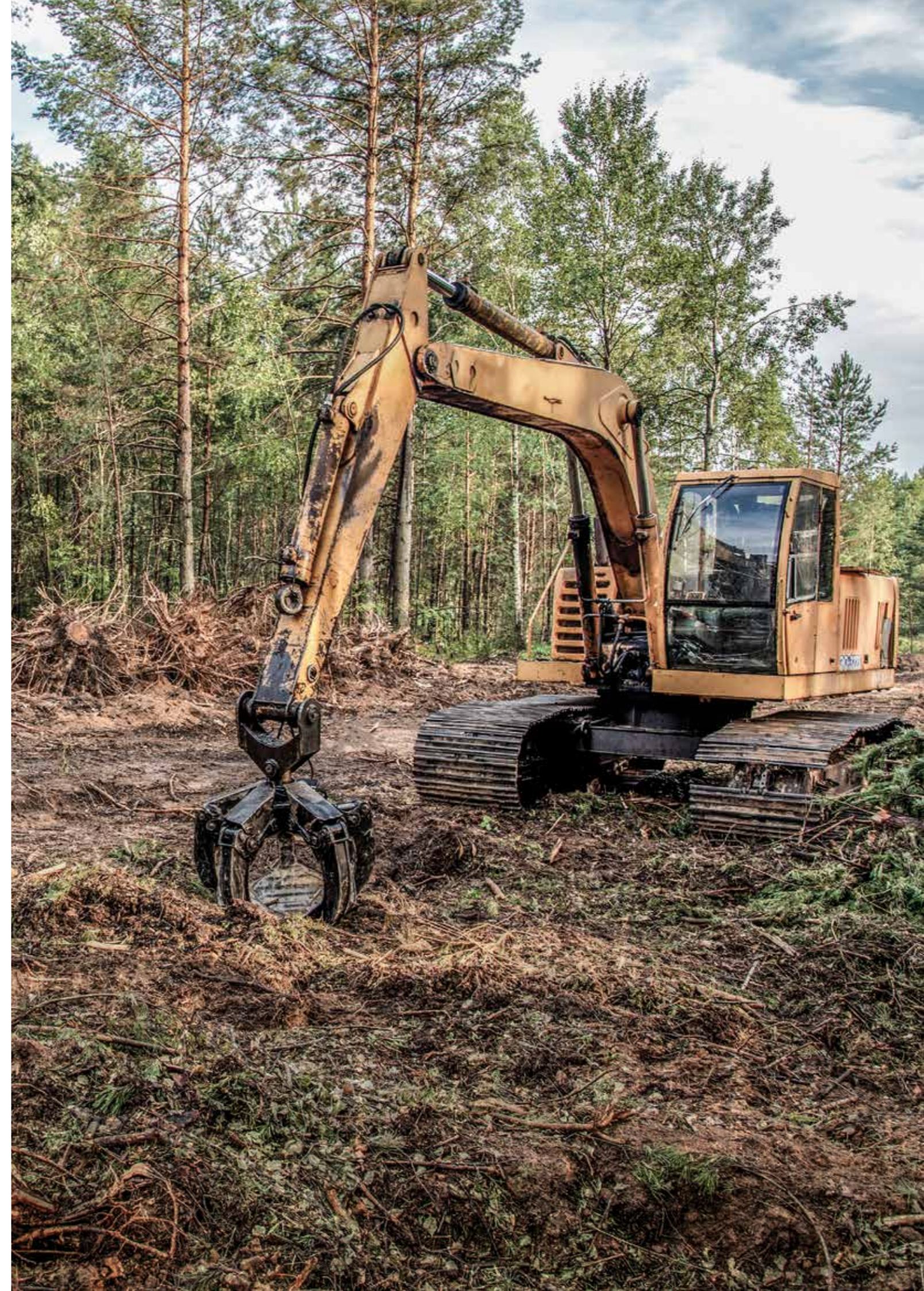

ERGONOMIC ADVANTAGE AND INCREASED EFFICIENCY

Quick-Lok couplings are threadless. With threading eliminated, torque settings are not required and both line side connection tooling and installation difficulties are no longer an issue. The easy installation process allows you to use Quick-Lok even in the most confined spaces often found in today's compact machines.

You also benefit from the cost-saving advantages that Quick-Lok delivers; for example, there is no need to invest in a vast range of expensive assembly tools or a skilled assembly labour force. Plus, any kind of operator-dependent variation in the connection process (which would add re-working time and cost) is completely ruled out. And Quick-Lok couplings are safer and more ergonomic as well. They simply push into place, reducing tiredness among the work force.

WORK SMARTER, NOT HARDER

- **Faster:** Quicker assembly times lead to improved manufacturing productivity
- **Easier:** With Quick-Lok, couplings click into place to ensure positive engagement every time
- **Smarter:** The connection process is error-proof, providing positive tactile feedback that the connection has been made
- **Simpler:** Verification is simple, and just requires the operator to pull back gently on the hose after connection.

With your assembly and check-up time reduced, your production output is optimised, simply by using the most cost-effective product. In addition, no assembly time is lost because of the need to re-work improperly torqued connections – all of which is good news for your business.

FIELD TESTS HAVE SHOWN THAT QUICK-LOK CONNECTIONS WERE MADE 10X FASTER THAN STANDARD THREADED CONNECTIONS.

THREE CUSTOMISED SOLUTIONS

To fully accommodate customer needs, Gates has invested in three alternative solutions to customer's connection problems. Whether your activities are in the hydraulic aftermarket or the hydraulic OEM business, we have a quick connection that meets your needs – and exceeds your expectations.

SOLUTION #1: QUICK-LOK HIGH (QLH)

A quick-connect solution using a QLH adaptor to establish a threadless port-to-port connection. QLH assemblies can be replaced either with threaded components or QLH threadless technology.

SOLUTION #2: QUICK-LOK DIRECT (QLD)

A quick-connect solution connecting directly into the port without the need for an adaptor. When used with an adaptor, QLD can be replaced either with threaded components or QLD threadless technology. When used without adaptors, QLD can only be replaced by QLD assemblies.

SOLUTION #3: QUICK-LOK LOW (QLL)

A low pressure quick-to-connect solution connecting directly into the port without the need for an adaptor. When used with an adaptor, QLL can be replaced either with threaded components or QLL threadless technology. When used without adaptors QLL can only be replaced by QLL assemblies.

SOLUTION #1: QLH CONNECTORS

Quick-Lok High connectors are designed to be used in combination with 1 and 2-wire braid construction hoses. As a result, they are suitable to replace threaded connections in approximately 70% of current hydraulic applications.

HIGH PRESSURE, HIGH PERFORMANCE

QLH couplings are part of the Gates MegaCrimp® product family, with proven expertise thanks to innovative design features: a MegaCrimp coupling with bite-the-wire tooth profile and patented C-insert ensuring a leak-free, concentric and full-length crimp that withstands impulse testing to 600,000 cycles, in combination with Gates Megasyss™ wire-braid hoses. System pressure for a QLH assembly is defined by the QLH termination size.

| ↔ | | ⌚ | | ⚙️ | |
|-------|----|-----|------|-------|--|
| D | | | | | |
| -size | DN | " | MPa. | MPa. | |
| -4 | 6 | 1/4 | 35.0 | 140.0 | |
| -6 | 10 | 3/8 | 35.0 | 140.0 | |
| -8 | 12 | 1/2 | 35.0 | 140.0 | |
| -10 | 16 | 5/8 | 28.0 | 112.0 | |
| -12 | 20 | 3/4 | 21.0 | 84.0 | |
| -16 | 25 | 1 | 21.0 | 84.0 | |

*For applications above 100°C, please consult with the Gates product application engineering team.



QLH: HOW TO CONVERT – AND WHY



Changing over from threaded connections to QLH couplings for assembly production is as simple as replacing your current adaptor with the QLH adaptor.



Component ports need no modification to accept Quick-Lok adaptors because they are available in most common international termination types.



Once installed, the adaptor is ready to receive the QLH assembly.



The unique Quick-Lok concept also reduces the need for a big stock inventory and allows you to cover all of your product needs with fewer number of references.



Whilst, for total flexibility and convenience, QLH assemblies are suitable for a very broad application range, even for high pressure hydraulic applications up to 35.0 MPa.



QLH: HOW TO INSTALL

PRE-ASSEMBLY

The QLH coupling is supplied with the necessary pre-installed seals and is protected by a disposable protective cap. The QLH adaptor, also supplied with a protective cap and plug, can be pre-installed into the port of the equipment to save time on the assembly line.



PARTIAL ASSEMBLY

The QLH coupling is partially inserted into the QLH adaptor, engaging the O-rings.



FULL ASSEMBLY

The coupling is fully inserted into the adaptor, creating a leak-free connection. For safety reasons (and to ensure a leak-free connection), once the QLH coupling is fully inserted, the connection is locked in place.



EASY TO SERVICE

For service in the field, removing a QLH assembly is simple and intuitive. Unlike other threadless designs, no special tools are needed. The only thing required is a common wrench to remove the adaptor from the port.

When replacing a QLH assembly, you must replace the QLH adaptor as well, in order to guarantee the overall quality of the connection.



QUICK-LOK HIGH MQLH

Male Quick-Lok High.

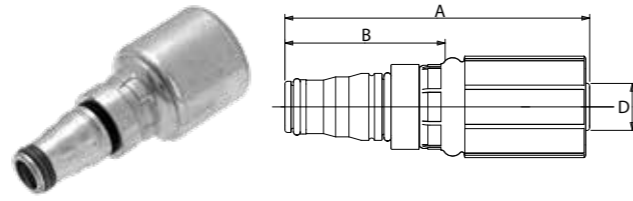

| ↻ | | | QLH | ↔ | | REF. |
|-------|----|-----|--------|-------|------|-----------|
| -size | D | " | A | B | G | |
| | DN | | mm | mm | | |
| -4 | 6 | 1/4 | 4MQLH | 67.0 | 41.0 | 4G4MQLH |
| -6 | 10 | 3/8 | 6MQLH | 69.0 | 41.1 | 6G6MQLH |
| -8 | 12 | 1/2 | 8MQLH | 79.0 | 41.5 | 8G8MQLH |
| -10 | 16 | 5/8 | 10MQLH | 79.0 | 41.5 | 10G10MQLH |
| -12 | 20 | 3/4 | 12MQLH | 93.0 | 42.0 | 12G12MQLH |
| -16 | 25 | 1 | 16MQLH | 101.0 | 44.2 | 16G16MQLH |

-4 to -8 size are 35.0 MPa (5000 psi); -10 & -12 size are 28.0 MPa (4000 psi); -16 size is 21.0 MPa (3000 psi). / Note: not to be used as a live swivel.

QUICK-LOK HIGH MQLH45

Male Quick-Lok High.

45° swept elbow.

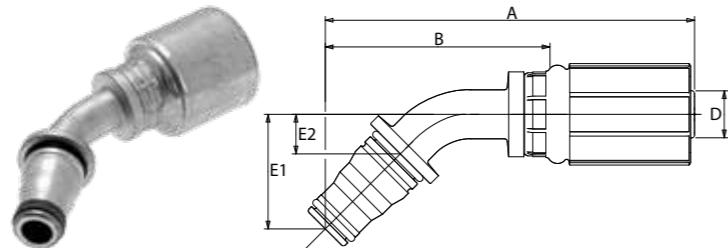

| ↻ | | | QLH | ↔ | | | | REF. | |
|-------|----|-----|----------|-------|------|------|------|-------------|--|
| -size | D | " | A | B | E1 | E2 | G | | |
| | DN | | mm | mm | mm | mm | | | |
| -4 | 6 | 1/4 | 4MQLH45 | 75.1 | 49.1 | 26.9 | 7.5 | 4G4MQLH45 | |
| -6 | 10 | 3/8 | 6MQLH45 | 81.6 | 53.7 | 27.7 | 8.3 | 6G6MQLH45 | |
| -8 | 12 | 1/2 | 8MQLH45 | 95.7 | 58.2 | 29.7 | 10.3 | 8G8MQLH45 | |
| -10 | 16 | 5/8 | 10MQLH45 | 104.6 | 67.1 | 32.1 | 12.7 | 10G10MQLH45 | |
| -12 | 20 | 3/4 | 12MQLH45 | 124.0 | 73.0 | 33.6 | 14.2 | 12G12MQLH45 | |
| -16 | 25 | 1 | 16MQLH45 | 139.5 | 82.7 | 36.1 | 16.7 | 16G16MQLH45 | |

-4 to -8 size are 35.0 MPa (5000 psi); -10 & -12 size are 28.0 MPa (4000 psi); -16 size is 21.0 MPa (3000 psi). / Note: not to be used as a live swivel.

QUICK-LOK HIGH MQLH90

Male Quick-Lok High.

90° swept elbow.

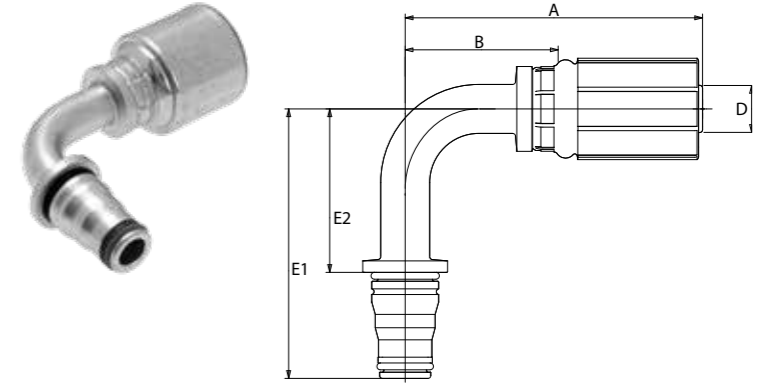

| ↻ | | | QLH | ↔ | | | | REF. | |
|-------|----|-----|-----------|-------|------|------|------|--------------|--|
| -size | D | " | A | B | E1 | E2 | G | | |
| | DN | | mm | mm | mm | mm | | | |
| -4 | 6 | 1/4 | 4MQLH90S | 55.6 | 29.6 | 45.5 | 18.0 | 4G4MQLH90S | |
| -6 | 10 | 3/8 | 6MQLH90S | 62.8 | 34.8 | 47.6 | 20.1 | 6G6MQLH90S | |
| -8 | 12 | 1/2 | 8MQLH90S | 80.3 | 42.9 | 53.1 | 25.6 | 8G8MQLH90S | |
| -10 | 16 | 5/8 | 10MQLH90S | 90.1 | 52.6 | 60.3 | 32.8 | 10G10MQLH90S | |
| -12 | 20 | 3/4 | 12MQLH90S | 110.1 | 59.1 | 64.3 | 36.8 | 12G12MQLH90S | |
| -16 | 25 | 1 | 16MQLH90S | 139.1 | 82.3 | 71.3 | 43.8 | 16G16MQLH90S | |

-4 to -8 size are 35.0 MPa (5000 psi); -10 & -12 size are 28.0 MPa (4000 psi); -16 size is 21.0 MPa (3000 psi). / Note: not to be used as a live swivel.

QUICK-LOK HIGH FQLH

Female Quick-Lok High.

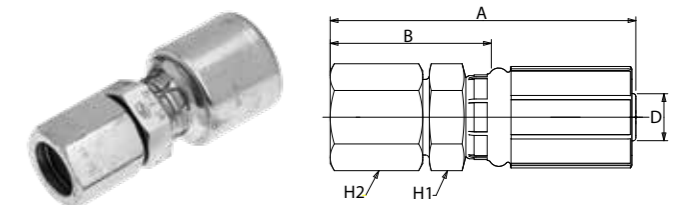

| ↻ | | | QLH | ↔ | | | | REF. | |
|-------|----|-----|--------|-------|------|------|------|-----------|--|
| -size | D | " | A | B | H1 | H2 | G | | |
| | DN | | mm | mm | mm | mm | | | |
| -4 | 6 | 1/4 | 4FQLH | 67.7 | 41.7 | 19.1 | 19.0 | 4G4FQLH | |
| -6 | 10 | 3/8 | 6FQLH | 69.7 | 41.8 | 22.0 | 22.0 | 6G6FQLH | |
| -8 | 12 | 1/2 | 8FQLH | 79.2 | 41.8 | 24.0 | 24.0 | 8G8FQLH | |
| -10 | 16 | 5/8 | 10FQLH | 80.3 | 42.8 | 27.0 | 30.0 | 10G10FQLH | |
| -12 | 20 | 3/4 | 12FQLH | 89.7 | 38.7 | 32.0 | 36.0 | 12G12FQLH | |
| -16 | 25 | 1 | 16FQLH | 101.7 | 44.9 | 41.0 | 41.0 | 16G16FQLH | |

-4 to -8 size are 35.0 MPa (5000 psi); -10 & -12 size are 28.0 MPa (4000 psi); -16 size is 21.0 MPa (3000 psi). / Note: not to be used as a live swivel.

BSP MBSPP-FQLH

Quick-Lok High adaptor BSP MBSPP to QLH.
Male BSPP thread with captive seal. 60° cone.
DIN 3852-11 form. ISO 1179-2.

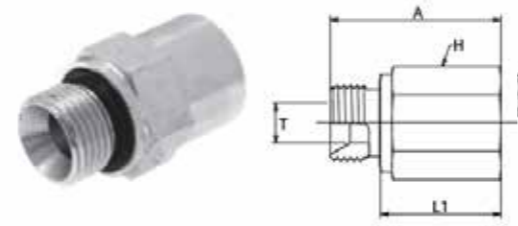

| QLH | | ↔ | | | | |
|--------|----------------|------|------|------|------|-------------------|
| | | A | L1 | H | T | |
| | | mm | mm | mm | mm | REF. |
| 4FQLH | G1/4" - 19 BSP | 44.5 | 32.5 | 22.0 | 4.7 | 4FQLH-4MBSPPCSC |
| 6FQLH | G3/8" - 19 BSP | 44.7 | 32.7 | 22.0 | 8.2 | 6FQLH-6MBSPPCSC |
| 8FQLH | G1/2" - 14 BSP | 47.0 | 33.0 | 27.0 | 11.0 | 8FQLH-8MBSPPCSC |
| 12FQLH | G3/4" - 14 BSP | 49.2 | 33.2 | 36.0 | 16.7 | 12FQLH-12MBSPPCSC |
| 16FQLH | G1" - 11 BSP | 51.0 | 33.0 | 41.0 | 22.2 | 16FQLH-16MBSPPCSC |

BSP MBSPPBKHD-FQLH

Quick-Lok High adaptor BSP MBSPPBKHD to QLH.
Male BSPP thread. Bulkhead. 60° cone.

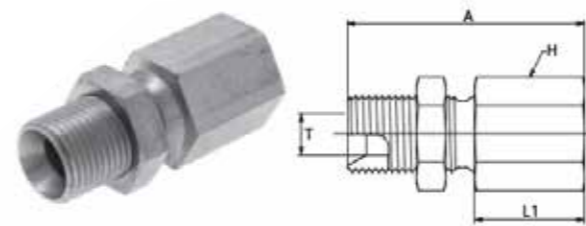

| QLH | | ↔ | | | | |
|--------|----------------|------|------|------|------|--------------------|
| | | A | L1 | H | T | |
| | | mm | mm | mm | mm | REF. |
| 4FQLH | G1/4" - 19 BSP | 62.0 | 30.0 | 19.0 | 4.7 | 4FQLH-4MBSPPBKHD |
| 6FQLH | G3/8" - 19 BSP | 62.0 | 30.0 | 22.0 | 8.2 | 6FQLH-6MBSPPBKHD |
| 8FQLH | G1/2" - 14 BSP | 65.0 | 30.0 | 27.0 | 11.0 | 8FQLH-8MBSPPBKHD |
| 12FQLH | G3/4" - 14 BSP | 68.0 | 30.0 | 36.0 | 16.7 | 12FQLH-12MBSPPBKHD |
| 16FQLH | G1" - 11 BSP | 71.0 | 30.0 | 41.0 | 22.2 | 16FQLH-16MBSPPBKHD |

DIN MMOR-FQLH

Quick-Lok High adaptor DIN MMOR to QLH.
Male metric thread with O-ring. ISO 6149-2, -3

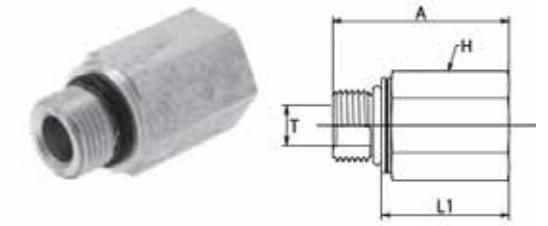

| QLH | | ↔ | | | | |
|--------|---------|------|------|------|------|---------------|
| | | A | L1 | H | T | |
| | | mm | mm | mm | mm | REF. |
| 4FQLH | M12X1.5 | 43.5 | 32.5 | 19.0 | 6.0 | 4FQLH-12MMOR |
| 4FQLH | M14X1.5 | 43.5 | 32.5 | 22.0 | 7.0 | 4FQLH-14MMOR |
| 6FQLH | M14X1.5 | 43.5 | 32.5 | 22.0 | 7.0 | 6FQLH-14MMOR |
| 6FQLH | M16X1.5 | 45.0 | 32.5 | 22.0 | 9.0 | 6FQLH-16MMOR |
| 6FQLH | M18X1.5 | 45.0 | 32.5 | 24.0 | 10.0 | 6FQLH-18MMOR |
| 8FQLH | M18X1.5 | 45.0 | 32.5 | 24.0 | 10.0 | 8FQLH-18MMOR |
| 8FQLH | M22X1.5 | 45.5 | 32.5 | 27.0 | 10.0 | 8FQLH-22MMOR |
| 10FQLH | M22X1.5 | 45.5 | 32.5 | 27.0 | 14.0 | 10FQLH-22MMOR |
| 12FQLH | M26X1.5 | 48.5 | 32.5 | 32.0 | 14.0 | 12FQLH-26MMOR |
| 12FQLH | M27X2 | 48.5 | 32.5 | 32.0 | 18.0 | 12FQLH-27MMOR |
| 16FQLH | M33X2 | 48.5 | 32.5 | 41.0 | 23.0 | 16FQLH-33MMOR |

SAE MB-FQLH

Quick-Lok High adaptor SAE MB 'Heavy Duty' to QLH.
SAE J1926-2. ISO 11926-2.

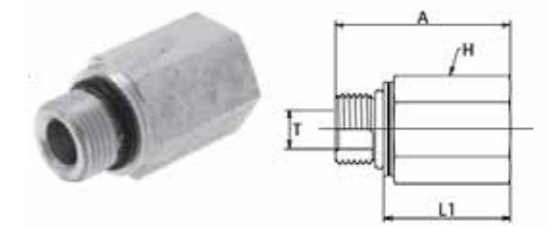

| QLH | | ↔ | | | | |
|--------|-----------------|------|------|------|------|-------------|
| | | A | L1 | H | T | |
| | | mm | mm | mm | mm | REF. |
| 4FQLH | 7/16" - 20 UNF | 42.0 | 31.0 | 19.0 | 4.0 | 4FQLH-4MB |
| 4FQLH | 9/16" - 18 UNF | 42.0 | 30.0 | 19.0 | 6.8 | 4FQLH-6MB |
| 6FQLH | 7/16" - 20 UNF | 42.0 | 31.0 | 22.0 | 4.5 | 6FQLH-4MB |
| 6FQLH | 9/16" - 18 UNF | 43.0 | 31.0 | 22.0 | 7.5 | 6FQLH-6MB |
| 6FQLH | 3/4" - 16 UNF | 43.0 | 29.0 | 24.0 | 10.0 | 6FQLH-8MB |
| 8FQLH | 9/16" - 18 UNF | 43.5 | 31.5 | 24.0 | 7.5 | 8FQLH-6MB |
| 8FQLH | 3/4" - 16 UNF | 44.5 | 30.5 | 24.0 | 10.0 | 8FQLH-8MB |
| 8FQLH | 7/8" - 14 UNF | 46.0 | 30.0 | 27.0 | 12.7 | 8FQLH-10MB |
| 10FQLH | 3/4" - 16 UNF | 47.0 | 33.0 | 27.0 | 10.0 | 10FQLH-8MB |
| 10FQLH | 7/8" - 14 UNF | 47.0 | 31.0 | 27.0 | 12.7 | 10FQLH-10MB |
| 10FQLH | 1.1/16" - 12 UN | 48.0 | 29.5 | 32.0 | 14.3 | 10FQLH-12MB |
| 12FQLH | 7/8" - 14 UNF | 48.0 | 32.0 | 32.0 | 12.7 | 12FQLH-10MB |
| 12FQLH | 1.1/16" - 12 UN | 50.0 | 31.5 | 32.0 | 15.5 | 12FQLH-12MB |
| 12FQLH | 1.5/16" - 12 UN | 50.0 | 31.5 | 41.0 | 19.8 | 12FQLH-16MB |
| 16FQLH | 1.5/16" - 12 UN | 50.0 | 31.5 | 41.0 | 21.0 | 16FQLH-16MB |

SOLUTION #2: QLD CONNECTORS

The QLD assembly connects directly into the port, eliminating the need for an adaptor. Direct-to-port QLD connectors are suited for applications up to 28 MPa (4000 psi), such as (but not limited to):

- Valves
- Manifolds
- Oil Coolers
- Joystick/Control Lines
- Pilot Lines
- Other Industrial Applications

Note: The system pressure of a QLD connection is defined by the connection of the port material and the QLD coupling.



DIRECT TO PORT AND LEAK-FREE

QLD couplings can be safely and simply pushed into place by hand, which is a key asset for tight pilot line installations. QLD assemblies connect directly into the port, eliminating the need for an adaptor. The QLD port locks the QLD stem into place for a leak-free connection and prevents the QLD coupling from being released or twisting loose during operation. Because the QLD direct-to-port solution does not require an adaptor, there is one leak point less and component costs are lower.

QLD: HOW TO CONVERT – AND WHY

- Gates has been working in close partnership with leading OEM suppliers to develop Quick-Lok direct-to-port solutions – eliminating the use of adaptors
- This adds further cost and time saving efficiencies to your assembly line
- Even where a port still has a threaded connection, changing to QLD just takes a click
- Simply replace your current adaptor with a QLD adaptor – there is no need to modify the component port and QLD connectors can be used in a wide range of applications
- QLD technology doesn't just increase productivity at OEM level – It can also be installed in one-tenth of the time of a threaded coupling
- In the long run, it reduces downtime as no assembly time is lost because of the need to re-work improperly torqued connections

QLD: HOW TO INSTALL

QLD components are supplied with a protective cap to keep them dirt-and-damage-free up until the moment of assembly.

- To install the coupling, remove the cap, align the coupling with the port and push it into place until the retaining clip is engaged
- Finally, pull the coupling in the reverse direction to verify that a secure connection has been made

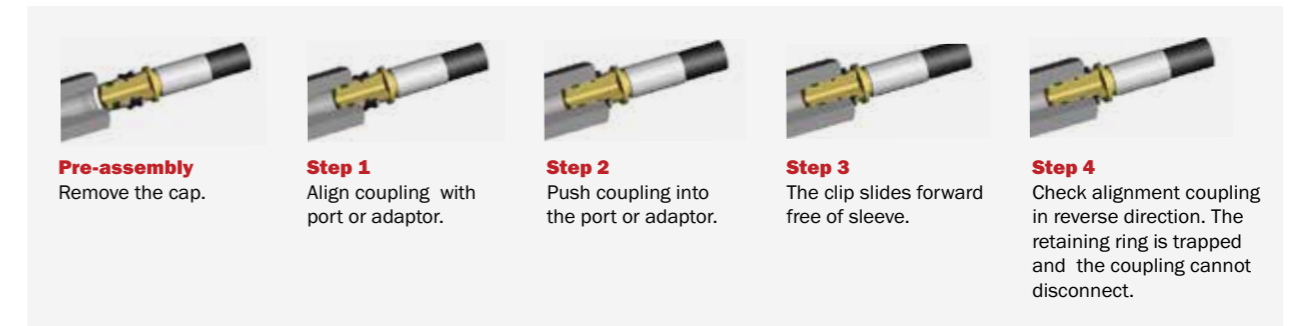

The QLD couplings have been tested to ensure that the push-in force is high enough to provide positive feedback that a connection has been made, but low enough to allow easy assembly on the line. Once the retaining ring is engaged, the assembly can neither be inadvertently disconnected, nor released under pressure.

EASY TO SERVICE

For service in the field, disconnecting a Quick-Lok assembly is very simple: just push down the connector, then use the Gates QLD release tool to keep the sleeve in place. The assembly will disconnect easily.



QUICK-LOK DIRECT MQLD

Male Quick-Lok Direct.

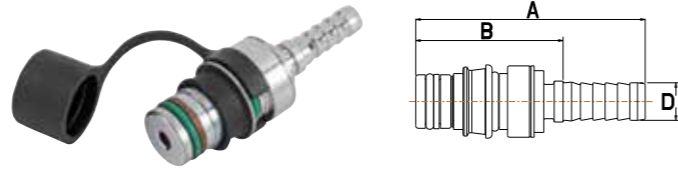

| D | | | A | | B | REF. |
|-------|----|-----|------|----|------|-------------|
| -size | DN | " | mm | mm | mm | P1T |
| -4 | 6 | 1/4 | 56.0 | | 37.9 | P1T04T1MQLD |
| -6 | 10 | 3/8 | 59.5 | | 38.2 | P1T06T1MQLD |

QLD is pressure rated up to 28.0 MPa (4000 psi).

QUICK-LOK DIRECT MQLD45

Male Quick-Lok Direct.

45° swept elbow.

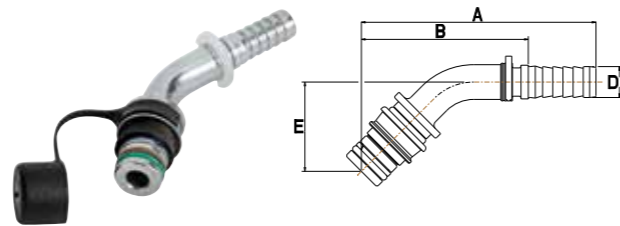

| D | | | A | B | E | REF. |
|-------|----|-----|------|------|------|---------------|
| -size | DN | " | mm | mm | mm | P1T |
| -4 | 6 | 1/4 | 64.6 | 46.5 | 26.5 | P1T04T1MQLD45 |
| -6 | 10 | 3/8 | 73.9 | 52.6 | 27.1 | P1T06T1MQLD45 |

QLD is pressure rated up to 28.0 MPa (4000 psi).

QUICK-LOK DIRECT MQLD90

Male Quick-Lok Direct.

90° swept elbow.

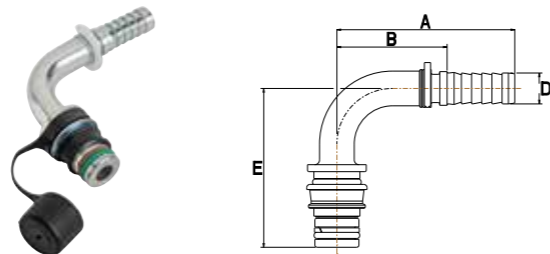

| D | | | A | B | E | REF. |
|-------|----|-----|------|------|------|--------------------|
| -size | DN | " | mm | mm | mm | P1T |
| -4 | 6 | 1/4 | 45.1 | 27.0 | 44.5 | P1T04T1MQLD90S-045 |
| -6 | 10 | 3/8 | 56.0 | 34.7 | 50.0 | P1T06T1MQLD90S-050 |

QLD is pressure rated up to 28.0 MPa (4000 psi).

QLD RELEASE TOOL

Release tool for QLD couplings.



| REF. | MATERIAL |
|----------------------------|----------|
| P1T T1 QLD RELEASE TOOL | STEEL |

SOLUTION #3: QLL CONNECTORS

QLL connections are an innovative solution primarily designed for transmission oil cooler applications operating at a maximum working pressure of 3.4 MPa (500 psi). Compared to QLD, QLL is a low-pressure termination designed for use in **non-impulse applications**. The fluorocarbon O-ring allows it to be used with fluid temperatures between -40°C and +149°C.

QLL: HOW TO CONVERT – AND WHY

- Gates has been working in close partnership with leading OEM suppliers to develop QLL solutions – eliminating the use of adaptors
- This adds further cost and time saving efficiencies to your assembly line
- Even where ports still have threaded connections, changing to QLL just takes a click
- Simply replace your current adaptor with a QLL adaptor – there is no need to modify component ports and QLL connectors can be used in a wide range of applications
- QLL technology doesn't just increase productivity at OEM level – it can be installed in one-tenth of the time of a threaded coupling
- In the long run, they also reduce downtime as no assembly time is lost because improperly torqued threaded connections have had to be re-worked

QLL: INSTALLATION

- To make the connection, the male QLL part is inserted into the female QLL port
- An O-ring provides the seal and a clip holds the connection together
- An assurance cap is used to verify that the male QLL part is fully inserted and that the clip is seated
- Pull the assurance cap back and push the male QLL part into the female QLL port as far as it will go. You will hear and feel the “click” connection when properly installed
- Pull back to verify it is connected, then slide the assurance cap into place, seating it against the quick connector hex.

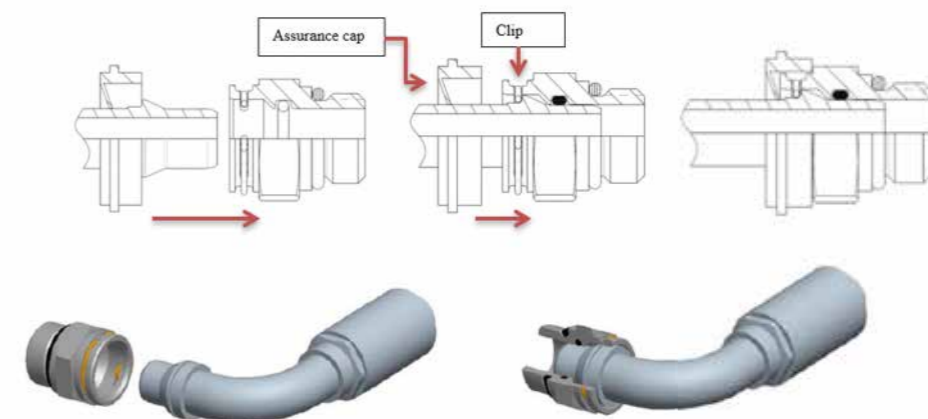

QUICK-LOK LOW MQLL

Male Quick-Lok Low.

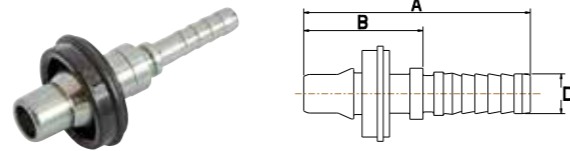

| D | | | A | | B | REF. |
|-------|----|------|------|------|----|-----------|
| -size | DN | " | mm | mm | mm | P1T |
| -3 | 5 | 3/16 | 50.6 | 30.6 | | 3P1T6MQLL |
| -4 | 6 | 1/4 | 53.0 | 34.9 | | 4P1T6MQLL |

QLL is pressure rated up to 3.4 MPa (500 psi). Only approved for non-impulse applications.

QUICK-LOK LOW MQLL45

Male Quick-Lok Low.

45° swept elbow.

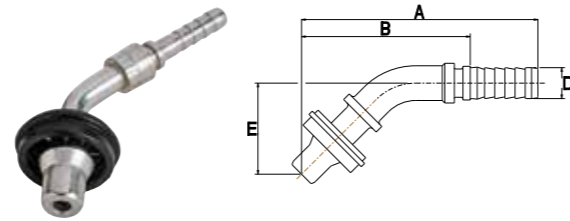

| D | | | A | B | E | REF. |
|-------|----|------|------|------|------|-----------------|
| -size | DN | " | mm | mm | mm | P1T |
| -3 | 5 | 3/16 | 63.4 | 43.4 | 21.0 | 3P1T6MQLL45-021 |
| -4 | 6 | 1/4 | 55.5 | 37.4 | 18.0 | 4P1T6MQLL45-018 |

QLL is pressure rated up to 3.4 MPa (500 psi). Only approved for non-impulse applications.

QUICK-LOK LOW MQLL90

Male Quick-Lok Low.

90° swept elbow.

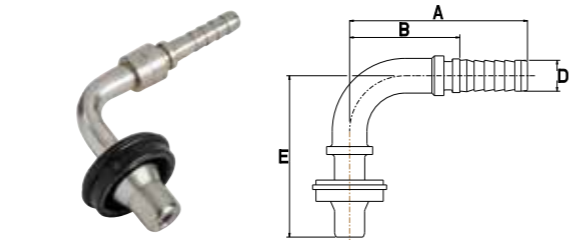

| D | | | A | B | E | REF. |
|-------|----|------|------|------|------|------------------|
| -size | DN | " | mm | mm | mm | P1T |
| -3 | 5 | 3/16 | 48.0 | 28.0 | 37.0 | 3P1T6MQLL90S-037 |
| -4 | 6 | 1/4 | 47.3 | 29.2 | 35.3 | 4P1T6MQLL90S |

QLL is pressure rated up to 3.4 MPa (500 psi). Only approved for non-impulse applications.

QLL RELEASE TOOL

Release tool for QLL couplings.



| REF. | MATERIAL |
|------------------|---------------|
| P1T | |
| QLL RELEASE TOOL | STEEL |
| QLL RELEASE TOOL | POLYPROPYLENE |

QUICK-LOK LOW SAE MB-FQLL

Quick-Lok Low Adaptor SAE MB 'Heavy Duty' to QLL. SAE J1926-2. ISO 11926-2.

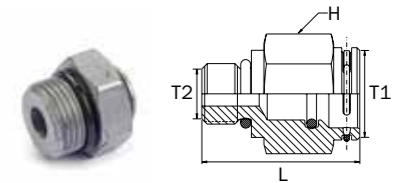

| QLL | T2 | L | H | REF. |
|-------|--------------|------|------|------------|
| FQLL | SAE 0 | mm | mm | FQLH |
| 6FQLL | 7/16"-20 UNF | 29.0 | 19.0 | 6FQLL-4MB |
| 6FQLL | 7/8"-14 UNF | 30.0 | 19.0 | 6FQLL-10MB |

QLL: DISCONNECTION

To disconnect, we recommend using the QLL release tool, which is available in both a premium (steel) and economic (polypropylene) version. If the seal requires replacement, the entire adaptor must be replaced.

No Quick-Lok (QLH, QLD or QLL) termination must ever be used as a live swivel. Rotation is only allowed when not under pressure and on an infrequent basis.

QUICK-LOK: DRIVEN BY POSSIBILITY

- Reduces the need for line side tooling.
- Eliminates thread and torque requirements.
- Provides a leak-free connection.
- Offers ergonomic advantages.
- Increases overall productivity.
- Lowers total cost of ownership.
- Ensures correct connections every time.
- Reduces/eliminates re-working requirements from production lines.
- Reduces/eliminates warranty claims.
- Reduces connection times.

| QUICK-LOK | HOSE STEM | HOSE SIZE | CONFIGURATIONS | WORKING PRESSURE | DIRECT-TO-PORT CONNECTION | CONNECTION BY ADAPTOR | RELEASE TOOL NEEDED |
|-----------|-----------|--------------|---------------------|------------------|---------------------------|-----------------------|---------------------|
| QLH | MEGACRIMP | -4 up to -16 | straight, 45° & 90° | max 35.0 | NO | YES | NO |
| QLD | P1T | -4 & -6 | straight, 45° & 90° | 28.0 | YES | OPTIONAL | YES |
| QLL | P1T | -3 & -4 | straight, 45° & 90° | 3.4 | YES | OPTIONAL | YES |

SAVE TIME, MONEY AND MORE, WITH GATES QUICK-LOK. STAY CONNECTED

Change the way you connect. Invest in what really counts. Get in touch with our application engineering team today to find out more about Quick-Lok and for guidance and advice about your optimum, business-focused connectivity solution.