



**DRIVEN BY POSSIBILITY™**

# **GATES SELF-ASSEMBLY SYSTEM**

**WITH GATES, YOU GET MORE THAN A HOSE  
GREASE-FREE OPERATION • HIGH PERFORMANCE • EASE OF USE**







DRIVEN BY POSSIBILITY™

# THE GATES INTEGRATED SYSTEM APPROACH: SUPERIOR PRODUCTS ARE JUST THE BEGINNING

The true value of the Gates self-assembly system comes from the Gates Integrated System Approach: all elements of the hose assembly process are designed together. They are meticulously adjusted and in unison. As a result, the Gates Integrated System Approach provides you and your customers with factory-quality assemblies which meet or exceed all international standards.

In addition, this approach ensures full compliance with the European Machinery Directive. Our dedication to offer you and your customers reassuringly superior products works results: we take pride in defending our reputation as the world's most trusted hydraulic hose assembly manufacturer.



# BECOME A TRUE GATES SOLUTION PROVIDER

## HOW DOES THE GATES INTEGRATED SYSTEM APPROACH WORK AND WHAT'S IN IT FOR YOU?



### SUPERIOR PRODUCTS, MANUFACTURED TO STRINGENT TOLERANCES

Our global hoses and couplings are manufactured to rigorous tolerances, making sure that they perform to such a high standard they'll work safely for a longer time.

**Benefit from less downtime.**

### ADVANCED SELF-ASSEMBLY MACHINES AND DIES, RIGOROUSLY VALIDATED

Our self-assembly machines make it quick and easy for you to produce the hose and coupling combinations you need. Gates dies have a special proprietary profile design that creates an almost perfectly cylindrical and durable crimp. We test and validate them at our factory so you can be sure they'll work time after time in your workshop.

**Increase the efficiency in your workshops.**

### OPTIMAL CRIMP DATA, DERIVED FROM METICULOUS TESTING

Each Gates crimper comes with validated crimp settings data for the complete European hose and coupling product range. So there's no need for time consuming trial-and-error to find the ideal settings! Gain fast and easy access to crimping instructions and crimp diameters via [ecrimp.gates.eu](http://ecrimp.gates.eu) or the eCrimp app.

**Set crimpers with the greatest of ease.**

### FACTORY-QUALITY PERFORMANCE MEETING OR EXCEEDING INTERNATIONAL STANDARDS

All this put together ensures the quality, performance and reliability that Gates is known for. When Gates hose and couplings are crimped in accordance with the Gates Integrated System, they yield factory-quality assemblies fully compliant to European Directives and legislation exceeding all international standards. Gates global wire-braid hose and MegaCrimp™ coupling assemblies are developed to withstand more than 3 times international standards. Gates spiral wire hose and GlobalSpiral coupling assemblies will work beyond a million impulse cycles.

**Trust Gates exceptional performance and reliability.**





DRIVEN BY POSSIBILITY™

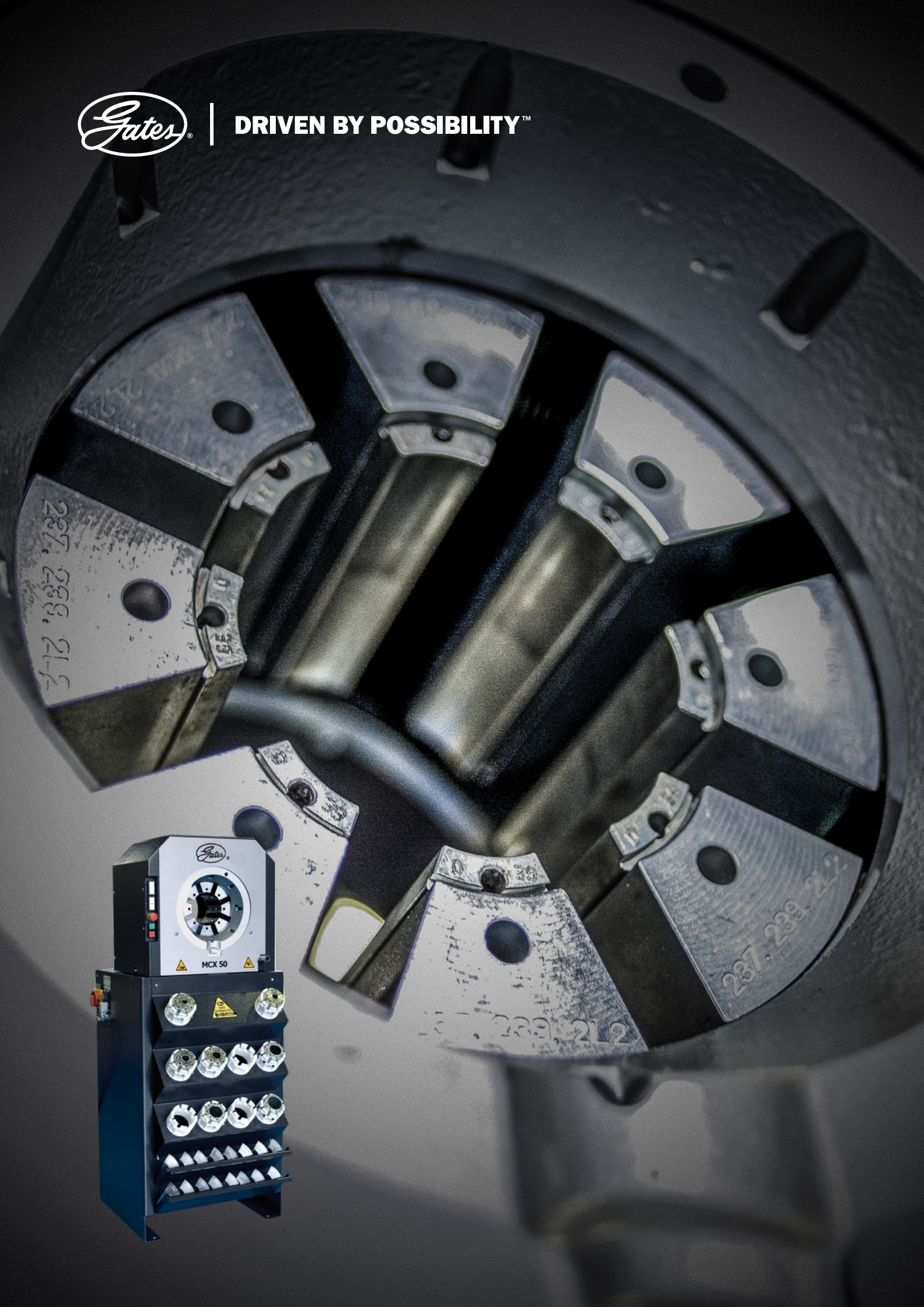





## THE NEW GATES SELF-ASSEMBLY MACHINERY PROGRAMME: WITH GATES, YOU GET MORE THAN A HOSE

### INNOVATIVE SELF-ASSEMBLY MACHINES AND DIES, RIGOROUSLY VALIDATED

Gates MCX range of grease-free self-assembly machines and dies are custom-designed to work with Gates hoses and couplings. Gates dies are characterised by a proprietary profile design for an optimal cylindrical crimp. They are tried, tested and validated to provide you with the most optimal crimp settings. Furthermore, Gates die sets are logically organised to facilitate die selection time after time.

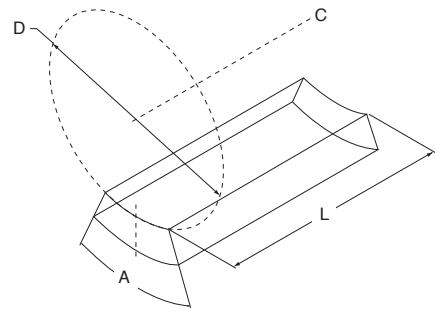

### GREASE-FREE OPERATION

Gates self-assembly machinery programme lowers your maintenance costs through grease-free operation. Gates MCX crimpers come with a unique self-lubricating slide bearing system, which fully eliminates metal-to-metal abrasion between master dies and the crimper head and decreases friction by 20%.

An additional result of the self-lubricating slide bearing system is that your working environment becomes cleaner, while dirt and debris are less likely to cause costly downtime. This enduring, maintenance-poor design brings the total cost of ownership of Gates crimpers to record lows.

### EASE OF USE

We believe products that are easy and pleasant to use improve user productivity. That is why all Gates applications for crimping, cutting and marking are designed to ensure fast, comfortable handling. In all electrical-driven crimpers, a standard built-in storage rack is positioned for quicker die selection, while die sets are logically organised and within easy reach of the operator. Field service crimping devices are easily portable and come with a detachable die storage case, solid and durable handles and resistant rubber protection layers. Feedback from our user community has shown that ergonomic design is widely appreciated, not in the least because of higher productivity figures and fast approval by local Health and Safety Executives.



### E-CRIMP: ONLINE CRIMP SETTINGS IN SECONDS









In line with the Gates Integrated System Approach (GISA) each Gates crimping machine comes with validated crimp settings for the complete hose and coupling range, allowing you to produce high-quality Gates assemblies yourself meeting and/or exceeding reference international standards. The European Gates eCrimp database provides you with the most up-to-date crimp data in just a few clicks! Gain fast and easy access to crimping instructions and crimp diameters. No need for time-consuming trial-an-error testing or sifting through a stockpile of outdated CD-ROMs to find the ideal machine settings! Simply go to [ecrimp.gates.eu](http://ecrimp.gates.eu) or download the mobile eCrimp app (available for Android and iOS) and get immediate access to the crimp library without registration.



# WORKSHOP MACHINERY OPTIONS

In the Gates workshop, safe, fast and efficient assembly of hydraulic hoses and couplings is made simple. All machines are custom-designed to work with a well-defined range of Gates hoses and couplings allowing production of factory-quality assemblies fully complying with European Directives and the most stringent international standards.

**No matter what your workshop needs, whether you are a starter, a professional, or a full-service workshop, Gates has the right product offering for you.**

	CUTTING	MARKING	CRIMPING
Full service 2"	MKX 40 	MSX 50 	MCX 50 
	MKX 30 	MSX 50 	MCX 30 
Professional service up to 1.1/4"	MKX 25 	MSX 50 	MCX 25 





## MOBILE MACHINERY OPTIONS

A Gates hose assembly is much more than the sum of its components. It is the combined result of a rigorous test regime and of a tightly controlled manufacturing process, both at Gates and at the point of assembly.

To reduce the risk of premature failure due to variations in the assembly process, Gates has developed a special proposition for mobile service operations allowing them to benefit from the simplified and superior Global range of no-skive hoses and couplings.

**And thanks to the Gates Integrated System, mobile service operators can offer their customers the superior quality and performance that they deserve.**

	CUTTING	MARKING	CRIMPING
Professional service up to 1.1/4"	<b>MKX 25</b> 	<b>MSX 50</b> 	<b>MCX 30</b> 
Starter up to 1"	<b>MKX 25</b> 	<b>MSX 50</b> 	<b>MCX 25</b> 





## FIELD SERVICE OPTIONS

In the field, every minute counts. In today's environment, equipment, whether it be agricultural, construction or mining, simply cannot afford unnecessary downtime. That's why Gates has developed a range of small, portable and easy to use crimpers specifically designed for end-users on site.

**And since these simple, lightweight machines are designed as part of the Gates Integrated System, end-users are assured of factory-quality no-skive assemblies – even in the field!**

CRIMPING	
No-skive spiral hose up to 1"	<b>MCX 20</b> 
	<b>MC 1001 manual</b> <b>MC 1001 air operated</b>  
Wire-braid hose up to 1"	





# TECHNICAL SPECIFICATIONS

CUTTERS		MKX 25		MKX 30	MKX 40
		DC	1 PHASE	3 PHASE	3 PHASE
POWER SUPPLY		12V	220V	380V	380V
MAXIMUM CAPACITY	WB	1.1/4"	1.1/4"	1.1/4"	2"
	4SW	1.1/4"	1.1/4"	1.1/4"	2"
	6SW	n/a	n/a	1.1/4"	2"
MOTOR (KW)		2.0	2.2	3.0	4.6
BRAKE MOTOR		NO	NO	YES	YES
SUCTION CONNECTION (PN)		8000-10375	8000-10375	8000-10368	8000-10395
CUTTING BLADE	SIZE (MM)	250x2.5x40	200x1.6x25.4	275x3x30	350x3x30
	PLAIN (PN)	<b>8000-10458</b>	8000-10464*	8000-10351	8000-10461
			8000-10465**		
	SLOTTED (PN)	n/a	<b>8000-10223*</b>	<b>8000-10222</b>	<b>8000-10386</b>
			<b>8000-10352**</b>		
	DIAMOND (PN)	8000-10459	8000-10463*	8000-10460	8000-10462
8000-10457**					
DIMENSIONS (MM)	H	365	540	300	430
	W	567	510	440	690
	L	470	400	540	745
WEIGHT (KG)		29	20	43	75
PRODUCT NUMBER		7480-19189	7480-19190	7480-19191	7480-19229

\*<s/n GA00454

\*\*>=s/n GA00454

PN in bold is the standard supplied cutting blade.





CRIMPERS		MC 1001		MCX 20
		MANUAL	PNEUMATIC	MANUAL
POWER SUPPLY		--	7bar/100psi	--
MAXIMUM CAPACITY	WB	1"	1"	1.1/4"
	4SW	--	--	1"
	6SW	--	--	--
CRIMPING FORCE (TON)		27	27	90
MOTOR (KW)		--	--	--
DIE SET		MC1001-Dxx	MC1001-Dxx	263-Dxx
CYCLE TIME (SEC)		--	--	--
DIE STORAGE		box	box	box
DIMENSIONS (MM)	H	460	460	370
	W	280	280	450
	L	390	390	470
WEIGHT (KG)		24	22	33
PRODUCT NUMBER		7480-19164	7480-19165	7480-19181
OPTIONS (PN)	MARKING DIES	--	--	x***
	QUICK DIE CHANGE	--	--	--
	BACK STOP	--	--	--
	FOOT PEDAL	--	standard	--

\* only with intermediate dies

\*\* marking die in type 239 only up to 239-D37

\*\*\* marking die in type 263 only up to 263-D35





MCX 25			MCX 30			MCX 50
DC	1 PHASE	3 PHASE	DC	1 PHASE	3 PHASE	3 PHASE
12V	220V	380V	12V	220V	380V	380V
1.1/4"	1.1/4"	1.1/4"	1.1/4"	1.1/4"	1.1/4"	2"
1"	1"	1"	1.1/4"	1.1/4"	1.1/4"	2"
--	--	--	1.1/4"	1.1/4"	1.1/4"	2"
130	130	130	180	180	180	280
1.8	2.2	3	1.8	2.2	3	5.5
239-Dxx	239-Dxx	239-Dxx	239-Dxx	239-Dxx	239-Dxx	239*/237-Dxx
39	39	19	41	41	20	18
rack	rack	rack	rack	rack	rack	rack
550	790	790	550	790	790	1400
475	600	600	475	600	600	580
395	550	550	395	550	550	610
115	160	160	125	170	170	410
7480-19182	7480-19183	7480-19184	7480-19185	7480-19186	7480-19187	7480-19236
χ**	χ**	χ**	χ**	χ**	χ**	χ**
7480-19194	7480-19194	7480-19194	7480-19200	7480-19200	7480-19200	7480-19195
--	--	--	--	--	--	7480-19198
--	--	--	--	--	--	7480-19199: ≤ s/n GA02022 8000-10481: > s/n GA02022

\* only with intermediate dies

\*\* marking die in type 239 only up to 239-D37

\*\*\* marking die in type 263 only up to 263-D35



## OVERVIEW: CRIMPING MACHINES



### MC 1001

Lightweight, portable crimper designed for reliability in field service. Comes with separate box, designed to contain complete set of dies. The pneumatic version has a foot-operated air pump. Crimps no-skive MegaCrimp® couplings for wire-braid hose up to 1".



### MCX 20

Powerful, lightweight, portable hand-operated crimper, ideal for field service operations. Comes with separate box, designed to contain complete set of dies. Crimps no-skive GlobalSpiral™ couplings up to 1" and no-skive MegaCrimp® couplings for wire-braid hose up to 1.1/4".



### MCX 25

Compact crimper for low-volume production. Ideal as starter machine or for small workshops. Crimps no-skive GlobalSpiral™ couplings up to 1" and no-skive MegaCrimp® couplings for wire-braid hose up to 1.1/4". Equipped with a die set storage rack allowing for logically organised die storage within easy reach of the operator, thus speeding up die selection and assembly. Also available for mobile service with DC power pack.



### MCX 30

Compact, operator-friendly machine to crimp the complete Gates range up to 1.1/4". Optional foot pedal to enable hands-free operation. Equipped with a die set storage rack allowing for logically organised die storage within easy reach of the operator, thus speeding up die selection and assembly. Also available for mobile service with DC power pack.



### MCX 50

Full-range crimper (up to 2" six spiral wire hose) for the professional workshop. Optional foot pedal to enable hands-free operation. Equipped with a die set storage rack allowing for logically organised die storage within easy reach of the operator, thus speeding up die selection and assembly.

Equipped with a user-friendly front plate design allowing to support a wider crimp capability. The special cut out provides more room to maneuver, hence facilitating the crimping of even more special configurations (left picture)

**OVERVIEW:****CRIMPING MACHINE ACCESSORIES****MARKING DIES**

To facilitate compliance with the European Machinery Directive, which insists that finished assemblies are marked with the manufacturer's name and the manufacturing date code, a range of marking dies is available for the MCX 50, MCX 30, MCX 25 and MCX 20 machines.

**QUICK DIE CHANGE**

The universal quick die change allows fast and easy change of dies without risk of damage to the die sets. The transparent shield of the quick die change allows you to quickly and safely position die sets into the master dies of the crimper head. A single press of the closing button is enough to lock the dies safely in place and rapidly produce a perfect hose assembly. When buying an electrical crimper, the QDC that goes together with the respective machine will be included in the package.



## OVERVIEW: CUTTING MACHINES



### MKX 25

The MKX 25 is a compact hose cutting machine, that cuts up to 1.1/4" of four spiral wire hose; making it an ideal cutter for mobile servicing.

Similar to all of our current cutters, the MKX25 incorporates a unique drive motor with twin bearings and oversized shafts, giving you a genuine benefit while cutting.

Straight cuts reducing scrap. Less contamination in the shop and in the end product. Maximal motor lifetime, giving you the lowest cost of ownership in the market. Faster cutting.



### MKX 30

Robust cutter for all types of workshops. Cuts up to 1.1/4" six spiral wire hose. The brake motor ensures the blade stops turning within 10 seconds after switch-off.



### MKX 40

Heavy-duty hose cutter allowing quick and reliable production across all hose size ranges. Cuts up to 2" six spiral wire hose. The brake motor ensures the blade stops turning within 10 seconds after switch-off. For workshop professionals who want to further enhance their set-up and improve ease-of-use.



## CUTTING BLADES

Be sure to replace your cutting blade on time. A worn-out blade puts greater pressure on the blade and motor, increasing the risk of a machine breakdown. Gates commits itself to offer spare cutting blades in 3 different versions: plain, slotted and diamond. Diamond cutting blades have the following advantages:

Cutting is twice as fast. Less smoke generation. Less heat emitting. Unchanged hardness of the cutting blade even at high temperatures. Less chance of debris in the hose. Less risk of separating the rubber from the wire. Lower power demand. Extended machine capability. Outlives standard blades by far at only twice the price!



## OVERVIEW: TOOLS



### MSX 50 MARKING MACHINE

This hand-operated marking machine is a precise, compact service-free bench unit for Gates ferrules, one-piece and two-piece fittings. The MSX 50 is equipped with a hand wheel to adjust the character setting to the ferrule for the requested marking depth. The slot in the character holder allows for easy character placement. Please contact Gates for order info on the required characters.



### MEGACRIMP® DIGITAL CALIPER

A handy tool which measures finished outside diameters. Special design for easy measuring of the finished diameters on -4, -5 and -6 MegaCrimp case.



### MEGACRIMP® INSERTION TOOL

The MegaCrimp® coupling insertion tool offers an easy way to confirm the right insertion depth for all Gates wire-braid hydraulic hoses. It also verifies the squareness of cut!



### PUSH-ON TOOL

Pushing couplings on hoses can be a tough job. Gates Push-on tool makes the insertion of couplings on hoses quick and easy. This hand-operated coupling machine, with its rugged cast iron and steel construction, eliminates the hard work of manually pushing stems into hoses and improves your hose assembly cost-efficiency.

### MKX SUCTION UNIT



Dust collection has become an important topic in European workplace regulation (e.g. ISO 4225 – ISO 1994) Therefore, professional workshops know that one of the most important pieces of machinery in the workshop is an adequate suction device. The MKX suction unit allows you to safely remove rubber particles and smoke released during the hose cutting operation. The particles are sucked into the container removing any hindering smell. The spark arrester between the cleaner box and the suction hose also ensures that glowing particles and rubber waste are immediately removed, thus minimizing the risk for fire. Depending which MKX hose cutter you have selected you can select the right adaptor to connect your hose cutter to the MKX suction unit in the technical specifications table on page 11.

**MKX40 adaptor ring:** 80 mm O connection (8000-10395)

**MKX30 adaptor ring:** 50 mm O connection (8000-10368)

**MKX25 adaptor ring:** 40 mm O connection (8000-10375)





# DIE SELECTION MATRIX: MEGASYS

-SIZE	HOSE						COUPLING	DIE	MC1001	MCX20	MCX25	MCX30	MCX50
									MC1001 -DXX	263 -DXX	239 -DXX	239 -DXX	239* /237 -DXX
-4	M6K	M5K	M4K	M3K			G	D21	7482-19810	8000-10190	7482-19924	7482-19924	7482-19924
	M2T	MXT	GTH	G3H	G2	G1	G	D21	7482-19810	8000-10190	7482-19924	7482-19924	7482-19924
-5		M5K	M4K	M3K			G	D22	7482-19811	8000-10191	7482-19925	7482-19925	7482-19925
	M2T	MXT	GTH		G2	G1	G	D22	7482-19811	8000-10191	7482-19925	7482-19925	7482-19925
-6		M5K	M4K	M3K			G	D22	7482-19811	8000-10191	7482-19925	7482-19925	7482-19925
	M2T	MXT	GTH	G3H	G2	G1	G	D22	7482-19811	8000-10191	7482-19925	7482-19925	7482-19925
	MXG4K						GS	D32			8000-10219	8000-10219	8000-10219
	EFG6K	EFG5K	EFG4K				GS	D33		8000-10192	7482-19926	7482-19926	7482-19926
-8		M5K	M4K	M3K			G	D33	7482-19812	8000-10192	7482-19926	7482-19926	7482-19926
	M2T	MXT	GTH	G3H	G2	G1	G	D33	7482-19812	8000-10192	7482-19926	7482-19926	7482-19926
	MXG4K						GS	22mm			8000-10398	8000-10398	8000-10398
	EFG6K	EFG5K	EFG4K				GS	D33		8000-10192	7482-19926	7482-19926	7482-19926
-10			M4K	M3K			G	D34	7482-19813	8000-10193	7482-19927	7482-19927	7482-19927
	M2T	MXT	GTH	G3H	G2	G1	G	D34	7482-19813	8000-10193	7482-19927	7482-19927	7482-19927
	MXG4K						GS	D33		8000-10192	7482-19926	7482-19926	7482-19926
	EFG6K	EFG5K	EFG4K				GS	D35		8000-10194	7482-19928	7482-19928	7482-19928
-12			M4K	M3K			G	D35	7482-19814	8000-10194	7482-19928	7482-19928	7482-19928
	M2T	MXT	GTH		G2	G1	G	D35	7482-19814	8000-10194	7482-19928	7482-19928	7482-19928
	MXG4K						GS	D35		8000-10194	7482-19928	7482-19928	7482-19928
	EFG6K	EFG5K	EFG4K				GS	D35		8000-10194	7482-19928	7482-19928	7482-19928
-16				M3K			G	D37	8000-10069	8000-10196	7482-19929	7482-19929	7482-19929
	M2T	MXT	GTH		G2	G1	G	D37	8000-10069	8000-10196	7482-19929	7482-19929	7482-19929
	MXG4K						GS	D37		8000-10196	7482-19929	7482-19929	7482-19929
	EFG6K	EFG5K	EFG4K				GS	D37		8000-10196	7482-19929	7482-19929	7482-19929
-20	M2T						G	D38			8000-10358	8000-10358	8000-10358
					G2	G1	G	D39		8000-10197	7482-19930	7482-19930	7482-19930
			EFG4K	EFG3K			GS	D39				7482-19930	7482-19930
	EFG6K	EFG5K					GS	D310				8000-10166	8000-10166
-24	M2T				G2	G1	GSP	D310					8000-10166
				EFG3K			GSP	D311					8000-10167
	EFG6K	EFG5K					GSM	D311					8000-10167
-32	M2T				G2	G1	GSP	D312					8000-10204
				EFG3K			GSP	D313					8000-10205
	EFG6K	EFG5K					GSM	D314					8000-10206

wire braid reinforcement   
  4 spiral wire reinforcement   
  6 spiral wire reinforcement   
 \* only with intermediate dies



## DIE SELECTION MATRIX: PRO SERIES

-SIZE	HOSE				COUPLING	DIE	MC1001	MCX20	MCX25	MCX30	MCX50
							MC1001-DXX	263-DXX	239-DXX	239-DXX	239-DXX
-4	Pro2T	Pro1T	CR2	CR1	EX	D31B			8000-10218	8000-10218	8000-10218
-5	Pro2T	Pro1T	CR2	CR1	EX	D31B			8000-10218	8000-10218	8000-10218
-6		Pro1T		CR1	EX	D31B			8000-10218	8000-10218	8000-10218
	Pro2T		CR2		EX	D32			8000-10219	8000-10219	8000-10219
-8	Pro2T	Pro1T		CR1	EX	D32			8000-10219	8000-10219	8000-10219
	Pro2T		CR2		EX	22mm			8000-10398	8000-10398	8000-10398
-10	Pro2T	Pro1T	CR2	CR1	EX	D33			7482-19926	7482-19926	7482-19926
-12	Pro2T	Pro1T	CR2	CR1	EX	D34			7482-19927	7482-19927	7482-19927
-16		Pro1T			EX	D35			7482-19928	7482-19928	7482-19928
	Pro2T		CR2	CR1	EX	D36			8000-10220	8000-10220	8000-10220

Note 1: For more hose coupling combinations we kindly refer you to [ecrimp.gates.eu](http://ecrimp.gates.eu) or the Gates mobile eCrimp app.

Note 2: High/Low Temp, MTF, XTF & Twin solutions follow the die set recommendation of its standard equivalent





## WHAT DOES THE SAFE HYDRAULICS TRAINING PROGRAMME OFFER?

- Safety and preventive maintenance training
- Global and local expertise by Gates application engineers
- Certified trainers
- Information tailored for assembly workshops and end-users

## HOW DOES THE SAFE HYDRAULICS TRAINING PROGRAMME WORK?

- Seminars via Gates exclusive partner network
- Covers the entire process: storage, selection, installation and inspection
- Includes an overview of relevant EU legislation, complete with practical examples



## THE GATES SAFE HYDRAULICS TRAINING PROGRAMME: A HIGHER STANDARD IN SAFETY

What makes a system really stand out? When all of the components work together immaculately – something that rarely happens when parts are sourced from multiple vendors. Mixing and matching couplings and hoses from different manufacturers can lead to premature assembly failure, as hoses, couplings, assembly equipment and crimping tolerances from different vendors are never guaranteed to offer safe interchangeability. Improper assembly and installation is bound to compromise performance and human safety. If a hydraulic hose assembly fails, the assembler can be held accountable for damages, as stated by European legislation (200642/CE - ISO 4413:2010).

To help you avoid material and personal hazards and liability issues, Gates Fluid Power Europe will provide you with expert information on safety issues affecting hydraulic hose assemblies through the Safe Hydraulics training programme.

**GATES IS YOUR ONE-STOP SHOP FOR SAFE, LONG-LASTING HYDRAULICS THAT ARE DESIGNED TO INTERACT FLAWLESSLY: HOSES, COUPLINGS, DIES, MACHINES, TOOLS ARE FINE-TUNED TO BE FULLY COMPATIBLE. PROVIDING YOU AND YOUR CUSTOMERS WITH SAFE, LONG-LASTING HYDRAULIC ASSEMBLIES IS OUR MAIN CONCERN.**



# GATES, YOUR KEY TO FACTORY-QUALITY PERFORMANCE MEETING OR EXCEEDING ALL INTERNATIONAL STANDARDS MATRIX

Choosing Gates self-assembly crimping, cutting and marking machines means choosing grease-free operation, high performance and ease of use. Whatever your requirements, teaming up with Gates guarantees ample choice. You can choose from a comprehensive range of self-assembly machinery which is fine-tuned to meet the specific requirements of workshops, mobile service operations or field repairs.

## TEAMING UP WITH GATES GUARANTEES YOU A THREEFOLD RETURN ON INVESTMENT:



### SUPERIOR PERFORMANCE AND UNRIVALLED SAFETY

All Gates hose assembly parts and Gates hose assembly machines are constructed in unison. This Integrated System Approach to product design ensures a perfect fit, unrivalled safety and performance meeting or exceeding all international standards.

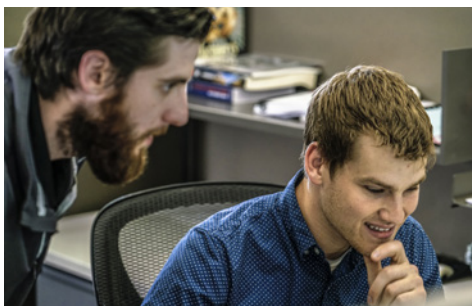

### PROFESSIONAL ADVICE AND SERVICES

Gates products come with a wide range of precision tools, crimp data, reference material, accessories and training sessions to facilitate your assembly operation in a safe and clean working environment.

COMPONENT	COST IN %
Hose	10%
Couplings	7%
Assembly cost	6%
Disconnection failed assembly	5%
Connection assembly	4%
Transportation & waiting time	26%
Production loss	43%

### LOWER TOTAL COST OF OWNERSHIP

Gates products are designed to go the long road. High-quality materials and advanced product features optimise your operations and bring downtime and maintenance costs to a reassuring low.

**You can find more information on the true value of teaming up with the leading total fluid power transmission supplier at [www.gates.com](http://www.gates.com)**





**DRIVEN BY POSSIBILITY™**

## **CUSTOMER EXPERIENCE TEAM**

Korte Kepestraat 21/51  
B-9320 EREMBODEGEM  
[inforequest@gates.com](mailto:inforequest@gates.com)