



EZ ALIGN™ GREEN

PRECISION LASER ALIGNMENT

OPERATING INSTRUCTIONS

PART NUMBER 7420-3000

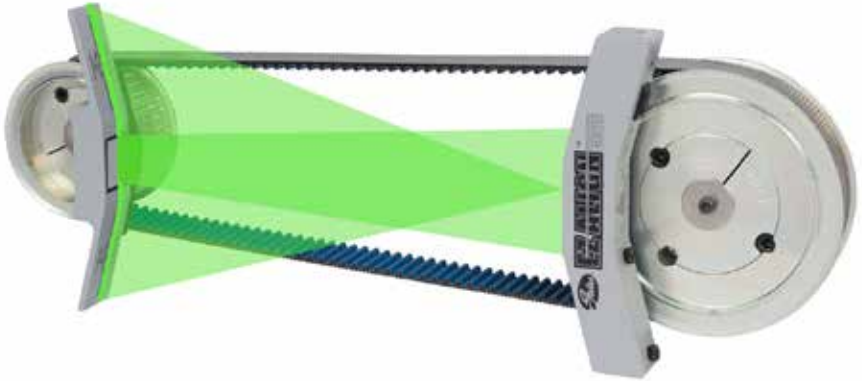



DRIVEN BY POSSIBILITY™

Thank you for your purchase of the Gates EZ Align™ laser alignment system. These instructions will introduce you to your new laser pulley alignment components and their operation. We are confident that Gates EZ Align™ will bring you many years of productive service if used properly.

The system consists of two units: the laser transmitter and the reflector. Each unit is equipped with powerful magnetic brackets that mount to almost any pulley or sprocket.

Gates EZ Align™ is the answer to misalignment in belt driven machinery. It replaces older, less accurate methods of pulley alignment such as using a straight edge, string line, or the human eye -- all techniques that lend themselves to error.

In today's demanding maintenance arena where tighter specifications and speedier results are a must, Gates EZ Align™ provides the accuracy and reliability that traditional methods cannot. With time and manpower at a premium, Gates EZ Align™ is your solution. Using the system requires no training and a single operator can do the job!

GATES EZ ALIGN™ GREEN

7420-3000

System consists of:

- **EZ Align™ Laser Transmitter** with AAA alkaline batteries and class II laser diode
- **EZ Align™ Reflector Unit**
- High density polyethylene **Carrying Case** with die cut foam insert
- **User Manual**



7420-3000 Gates EZ Align™ Green with carrying case and cut foam insert

EZ Align™ Laser Transmitter (left) and **EZ Align™ Reflector** (right)



FOREWORD

Welcome to laser pulley alignment using Gates EZ Align™. This patented, easy-to-use device from Gates Corporation will enable you to perform pulley alignment tasks with ease and precision.

This document is intended not only to guide you on the operation of the system, but also to provide useful and related information about belt and pulley alignment.

An aligned pulley system reduces both pulley and belt wear, and reduces equipment vibration, which in turn leads to improved machine performance. Proper pulley alignment reduces unscheduled downtime, and improves the reliability of your equipment.

Gates EZ Align™ provides an innovative approach to alignment, using Gates tested, proven reflected laser beam technology.

At Gates Corporation, we strive to produce high quality documentation, and therefore welcome your feedback. If you have comments or suggestions to help us improve our documentation, please let us know by emailing PTPAsupport@gates.com.

INTENDED USE

Gates EZ Align™ is designed for aligning belt drives in industrial environments. This simple alignment system requires only one operator. Gates Corporation assumes no liability for damage or injury resulting from uses other than those described in this document.

CE COMPLIANCE

Gates EZ Align™ conforms to all relevant CE requirements. Per Annex II.B of the Machinery Directive (98/37/EC) IEC608-25-1 EN 60825-1

LASER SAFETY

The Gates EZ Align™ system uses a Class II laser. Class II lasers comply with the requirements outlined in the FDA specification 21 CFR Ch. 1, Parts 1040.10 and 1040.11, as well as ANSI standards. The Gates EZ Align™ operates at a wavelength of 532nm. **DO NOT** look into the laser beam at any time, including during set-up and adjustment of operation.

CALIBRATION

The Gates EZ Align™ is factory calibrated and therefore should not require any adjustments. It is recommended however, that the unit be returned to the factory or an authorized service center each year for calibration.

BATTERY OPERATION

Gates EZ Align™ is powered with 2 AAA alkaline batteries with an operating time of approximately 25 hours. To replace the depleted batteries, simply turn and remove the two thumb screws on the back of the transmitter to expose the battery compartment. Remove the old batteries and replace them with new ones.

CAUTION

Always lock-out the electrical power to the motor prior to performing any maintenance

Failure to do so could result in serious injury or death to personnel and may cause damage to equipment

2 AAA Alkaline Batteries



Battery Thumb Screw Hole Location

Rocker Switch Laser / Off / Flashlight

LED FLASHLIGHT

Built-in LED flashlight combined in one convenient, compact design. Ultra-bright white LED with 100,000 hour bulb life, 150 lumens and 5000K LED Color.



MAGNETIC BRACKETS

Powerful magnetic brackets hold the Gates EZ Align™ firmly in place

Due to the powerful magnets on the Gates EZ Align™ units, we recommend handling the assembly with care. The units should be kept away from magnetic materials such as watches, spectacle frames and other items that could be damaged.

When not in use, the Gates EZ Align™ magnetic units should be stored in their durable case.

For maximum performance, ensure that the optics on the laser transmitter, the reflecting surface on the reflector and the outside housing of both units are kept clean and dust free. The units may be cleaned with a lint-free cloth or a swab using a premium glass cleaner solution.



GETTING STARTED

GATES EZ ALIGN™ SET-UP

Pulley alignment has never been so simple. Open the Gates EZ Align™ case and remove the two compact and durable units that comprise the alignment system. Turn the laser unit on using the rocker switch located on the back of the transmitter.



Do not look into the laser beam at any time! Ensure that the machinery or equipment to be aligned has been locked out and tagged out.

Mount the units on the pulley faces to be aligned. The reflector should be mounted onto the pulley to be moved or adjusted, while the laser transmitter should be mounted onto the stationary pulley. The operator should determine which pulley is movable and which is stationary. The movable pulley is often the smallest one, and is often mounted to the motor shaft. In some cases both pulleys and shafts may need to be adjusted to achieve the desired alignment.

Check to see if the offset distance from the pulley mounting face to the groove is the same for both pulleys. If not, the optional Offset Bracket Kit may be very helpful.

STANDARD MAGNETIC MOUNTING

The Gates EZ Align™ is equipped with a powerful magnet bracket assembly, allowing the operator to mount the system on almost any pulley face, quickly and easily.



NONFERROUS PULLEYS AND SPROCKETS MOUNTING

When mounting Gates EZ Align™ to a nonferrous pulley or sprocket, use the optional QUICK-GRIP Micro One-Handed Bar Clamp.



OFFSET BRACKET KIT (OPTIONAL)

Use the optional Offset Bracket Kit with pulleys when a large offset is required. The kit includes a 1/2-inch and a 3/4-inch offset bracket. Combine both offset brackets to achieve a 1 1/4-inch offset.

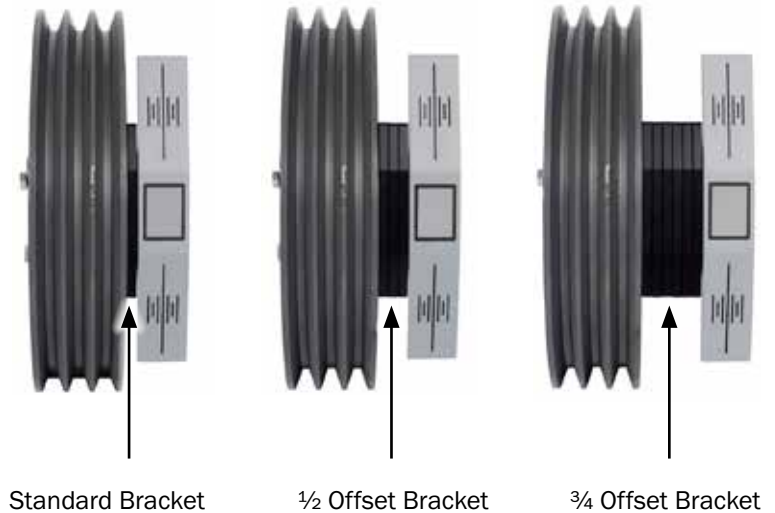

Standard Bracket

1/2 Offset Bracket

3/4 Offset Bracket

ALIGNMENT CONDITION CHECK

Misalignment conditions include vertical angularity, horizontal angularity and axial offset. The position of the transmitted laser line on the *reflector* indicates vertical angularity and axial offset. Horizontal angularity is indicated by the position of the reflected laser line on the *transmitter*.

TYPICAL MACHINE MISALIGNMENT CONDITIONS

Vertical Angularity

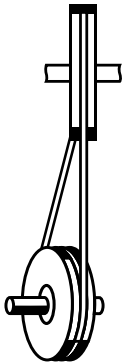

Axial Offset

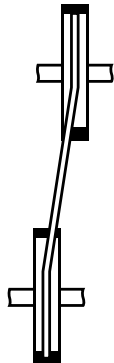

Horizontal Angularity

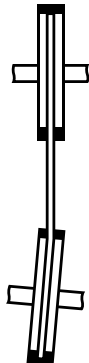

MISALIGNMENT CONDITIONS AS DISPLAYED ON THE GATES EZ ALIGN™

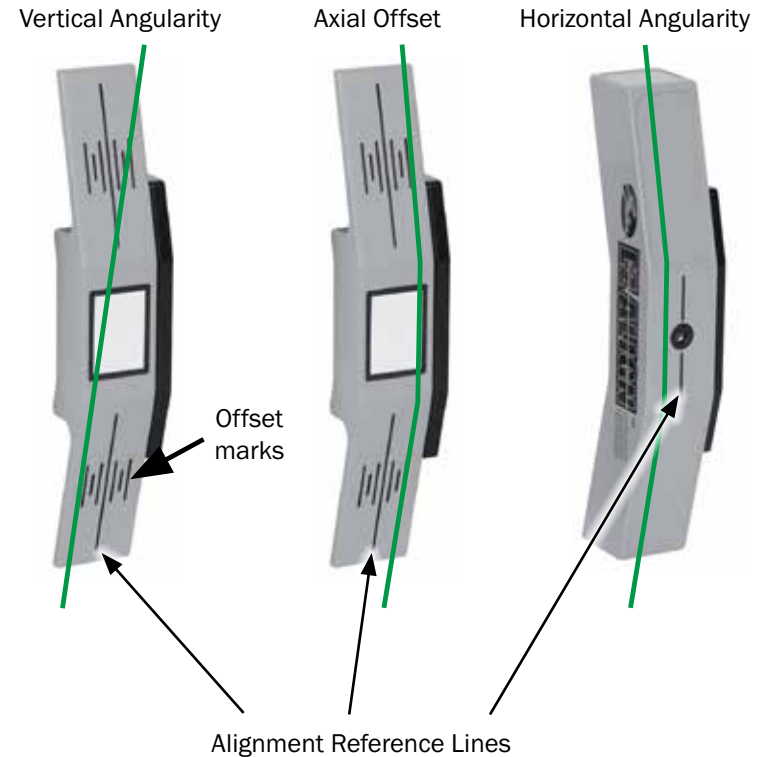

For different pulley edge thicknesses, use the offset marks on the face of the reflector to establish the amount of offset. The marks are in 1/8-inch increments.

Alignment processes should be carried out in an area protected from bright sunlight, or in a shaded area, to allow easy viewing of the laser line on the Gates EZ Align™ units.

CORRECTING PULLEY MISALIGNMENT

1. Correct vertical angularity by shimming the movable machine using precut 304 stainless steel shims. Correction of this angular misalignment can be observed on the reflector.
2. Correct axial offset by adjusting the movable pulley or machine axially. This correction can also be observed on the reflector unit.
3. Correct horizontal angularity by adjusting the movable machine laterally. The correction can be viewed on the laser transmitter during adjustment.



By following the three steps above, aligning the belt drive should be completed quickly. However, one alignment correction may affect other alignment conditions, so these steps may need to be repeated until the system is completely aligned.

Good alignment is achieved when the transmitter laser line and the corresponding reflected laser line coincide with the reference lines on the reflector and laser transmitter respectively.

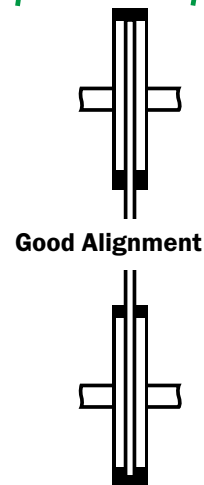

IMPORTANCE OF GOOD PULLEY ALIGNMENT

Good pulley alignment increases belt drive reliability and efficiency by reducing premature wear or failure of pulleys, belts and bearings. Pulleys can be aligned using conventional string and straight-edge methods, but this is often time consuming and prone to error.

Gates EZ Align™ is a laser system specifically designed for the alignment of belt driven equipment. Patented and proven reflected laser beam technology significantly helps to reduce drive installation time, manpower and potential errors associated with pulley alignment and installation.

The Gates EZ Align™ system uses a return beam angle that is twice the angle of incidence, so the reflected beam travels twice the distance, dramatically enhancing accuracy. Alignment is indicated with great precision, resulting in labor savings and increased production uptime.

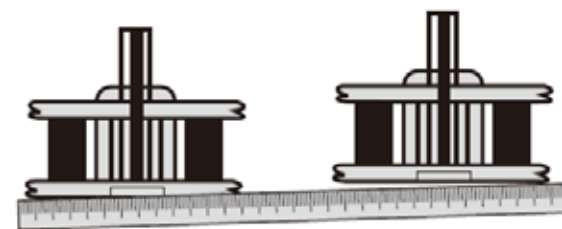

Straight-Edge Method



String Line Method

MACHINE PREPARATION

Before commencing any work ensure basic safety rules are adhered to.

CAUSES OF BELT FAILURE

Before beginning pulley alignment, examine potential causes of belt or pulley failure and correct them to prevent recurrence. Some causes of failure could include poor drive maintenance (wrong belt tension, pulley misalignment), environmental factors (sunlight, harsh temperature fluctuations), improper installation (wrong belts/sheaves, belts forced onto grooves), or operating factors (overload, shock load).

INSPECTION

Perform a visual inspection of the belts and of each pulley and its grooves. Look and feel for cracks, chips, or excessive groove wear. Proper contact between the belts and the pulleys must be ensured.

SOFT FOOT

Inspect the movable machine for “soft foot.” Feeler gauges can be used under a loosened foot to measure the gap. Shim the machine foot with the largest amount of gap (the amount indicated with the feeler gauges) until no reading is larger than 0.05mm (0.002” or 2 mils). Use precut 304 stainless steel shims. Severe “soft foot” distorts the machine frame when bolted down, causing damage to seals and bearings. It could also lead to high vibration levels on the machine bearings.



Loose clothing or long hair must never be allowed anywhere near belt-driven machinery. All equipment MUST be locked out and tagged out.

Worn belts or pulleys and other components should be replaced before proceeding with pulley alignment.

DRIVE BELTS

The condition of the worn belt is a good indication of the type of misalignment or other problems that may be present. Belts must be changed as soon as undue wear is detected. For a multiple-belt drive, all belts must be replaced together. Only belts from the same manufacturer should be combined together in order for the belts to share the load equally.

In order to replace the belts on a belt drive system, they must first be loosened. This is often accomplished by simply loosening the driver or driven unit and reducing the center distance. In other cases, an idler pulley may need to be loosened and moved. Belts must never be forced or rolled onto a pulley as this can damage the pulley as well as the belt tensile cord.

New belts must be properly stored. They should be kept in a cool, dry place with no exposure to direct sunlight or heat. They also should not be hung from single pegs. For further information, refer to Gates *Belt Drive Preventive Maintenance & Safety Manual*.

PULLEYS

If installing new pulleys and belts, ensure that the correct belt/pulley combination and the correct size belts have been selected. Existing pulleys should be inspected carefully for wear and replaced if necessary. Consult Gates *Belt Drive Preventive Maintenance & Safety Manual*.

PULLEY RUN-OUT

Axial pulley run-out will influence alignment readings. Axial run-out should be confirmed to be within recommended limits.

PULLEY ALIGNMENT

There are three basic parameters that describe pulley misalignment. These include vertical angularity, horizontal angularity, and axial offset, and may occur in any combination.

Vertical Angularity

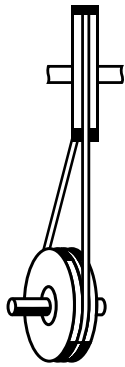

Axial Offset

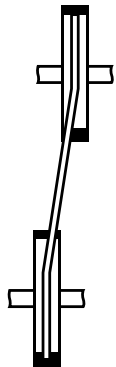

Horizontal Angularity

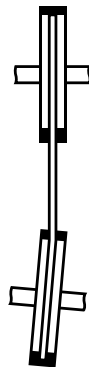

There are several pulley alignment methods. The most common include the straightedge or string methods, in which the straightedge or strings must touch the two edges of each pulley face simultaneously (four-point contact for drives with two pulleys). The pulleys should be rotated half a turn and checked again. Since a string can bend around corners, it is not easy differentiating between axial offset and horizontal angularity when only three-point contact is made. A straightedge or string also cannot always detect twist angle.

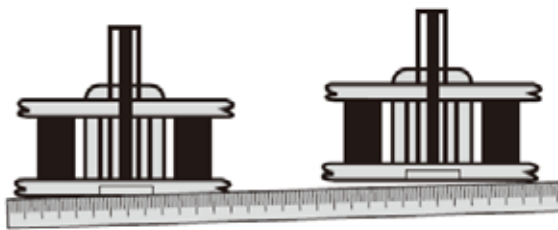

Straight-Edge Method



String Line Method

By contrast, the Gates EZ Align™ units mount magnetically to the face of most pulleys. The transmitter unit projects a laser line onto the reflector unit, which is magnetically attached to the other pulley face. Alignment involves ensuring that the transmitted and reflected laser lines match with the respective reference lines.

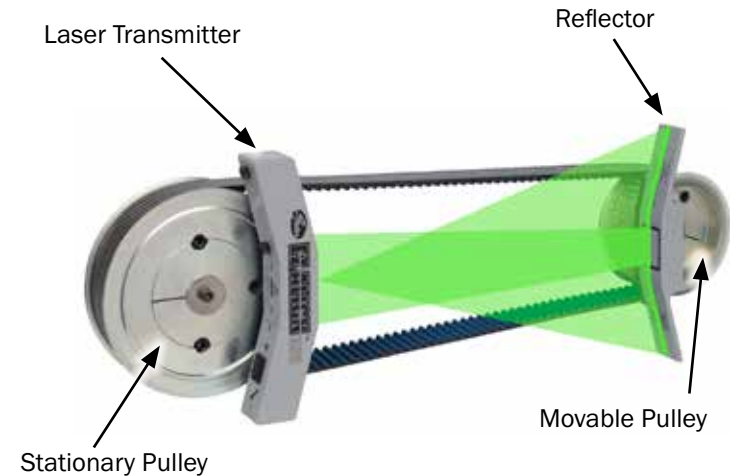

The following diagrams depict misalignment conditions using the Gates EZ Align™ and the corresponding corrections as observed on the units.

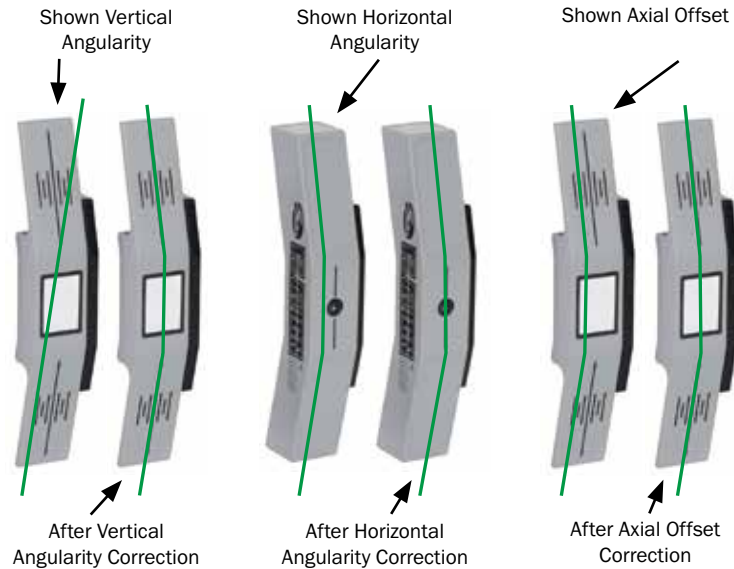

Vertical angularity should be corrected first. This is done by shimming the unit that the movable pulley is mounted to. The next step is to correct horizontal angularity. This is accomplished by shifting or twisting the position of the unit that the movable pulley is mounted to. Use lateral jackscrews if available, otherwise the unit will need to be loosened and re-positioned. Finally, correct axial offset by moving the unit that the movable pulley is mounted to axially or reposition one of the pulleys on its shaft. Since performing one alignment correction almost invariably affects the other alignment conditions, this process may have to be repeated several times.

Gates EZ Align™ enables all three alignment conditions to be monitored simultaneously. The accuracy of the alignment is greatly increased and the process can be completed quickly and easily.

The sequence in which the misalignment correction is carried out may vary from one situation to the next.

Incorrect belt tension (as well as pulley misalignment) adversely affects belt drive reliability and efficiency. After the pulleys have been aligned, it is very important to tension the belts to manufacturer's recommendations.

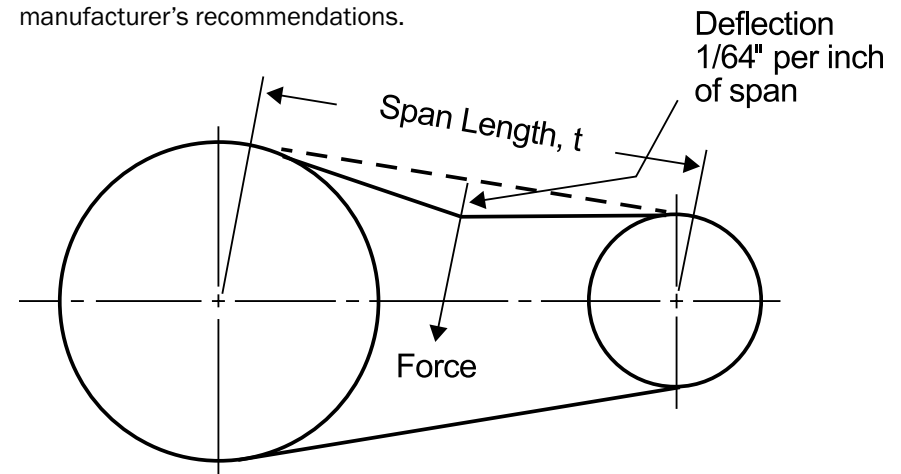

FORCE-DEFLECTION METHOD OF BELT TENSIONING:

1. Measure the belt span length and calculate the desired deflection distance (1/64" per inch of span length).
2. Using a spring scale, press down on the belt in the approximate center of the span, and deflect the belt to the desired level. When the desired deflection distance has been reached, note the force registered on the spring scale.
3. Adjust belt tension until the force required to achieve the desired deflection distance is within the belt manufacturer's recommended force values for the type of belts being used. New belts generally require higher tension levels than used belts because they have not been run in.

It is possible for belt tension adjustments to alter pulley alignment, and for pulley alignment adjustments to alter belt tension levels. The Gates EZ Align™ tool will help monitor the pulley alignment condition as belts are adjusted for the correct tension level.

MEASURING BELT TENSION WITH THE GATES SONIC TENSION METER:

The Gates Sonic Tension Meter measures belt span tension easily and accurately. Belt tension is measured by plucking the belt span while holding a sensor close by. Belt tension is adjusted until the belt span frequency, or measured tension level, is within manufacturer's recommendations.

The final step is to operate the belt drive system for a few hours, allowing the belts to stretch and seat properly in the pulley grooves. The belt tension level should then be checked to make sure it is within manufacturer's recommendations for new belts. Now operate the belt drive for at least 72 hours. The belt tension level should be checked again to make sure it is within manufacturer's recommendations for used belts.

MAINTENANCE

Gates EZ Align™ is designed with durable aluminum housing designed to withstand harsh environments. However, as with any precision instrument, care should be taken to avoid unnecessary abuse.

1. The lenses of the transmitter and reflector windows are coated with high performance film. To clean, use a lint-free cloth or swab using a premium glass cleaner solution.
2. The outside aluminum housing may be cleaned with a clean damp cloth.



Before operating the machinery check to make sure all tools and equipment have been properly stowed and all guards have been securely replaced.

REPAIR / SERVICE INSTRUCTIONS

1. Pack the equipment securely for shipment in the original carrying case.
2. Enclose a note or letter including contact information and the nature of the request or problem. If the unit is under warranty, provide confirmation of the purchase date.
3. If requested, estimates for non-warranty repairs will be provided, otherwise work will begin as soon as possible.
4. Return the equipment prepaid and insured to the Gates Corporation Service Center. For quick turn around, "2nd Day Air" or air shipment is recommended.
5. There will be no charge for repairs within the warranty period due to defective materials and/or workmanship after the unit has been received.

FOR REPAIRS SEND UNITS TO:

GATES CORPORATION
c/o Seiffert Industrial, Inc.
Attn: Service Department
1323 Columbia Drive, Suite 305
Richardson, TX 75081 USA

800-777-6363



STATEMENT OF LIMITED WARRANTY

Gates Corporation warrants the Gates EZ Align™ to be free of defects in material and workmanship for a period of two (2) years. This twenty four (24) month warranty period begins when the unit is received by the purchaser.

Gates Corporation will repair or replace, at its option, any defective part of components of which notice has been given during the warranty period. Travel and per diem expenses, if required, to and from the place where repairs are made, will be charged to the purchaser at the prevailing rates.

Customers should send units to Gates Corporation (use address on previous page) for warranty repairs; freight prepaid.

Any evidence of negligent, abnormal use, or accident with exception of the previously stated warranty or an attempt to repair equipment by other factory authorized personnel using Gates Corporation certified or recommended parts, automatically voids the warranty.

Special precautions have been taken to assure proper calibration; however, calibration is not covered by this warranty. Calibration maintenance is the responsibility of the user.

The foregoing states the entire liability of Gates Corporation regarding the purchase and use of its equipment. Gates Corporation will not be held responsible for any consequential loss or damage of any kind.

This warranty is in lieu of all other warranties, except as set forth above, including any implied warranty merchantability or fitness for a particular purpose, are hereby disclaimed. This warranty is in lieu of all other warranties, expressed or implied.



RECOMMENDED PULLEY ALIGNMENT VALUES

The standard limit for V-belt drive alignment is 0.5 degrees, and 0.25 degrees for synchronous drives. Most major belt and pulley manufacturers specify these values. Pulley alignment can be set closer than this if the alignment procedure is carefully followed. The following table converts degrees of misalignment to mils/inch and mm/100 (of pulley diameter) of misalignment between the projected planes of the pulley faces.

ANGLE OF MISALIGNMENT (DEGREES)	MM / 100MM	MM / INCH
0.1	0.18	1.75
0.2	0.35	3.49
0.3	0.52	5.24
0.4	0.70	6.98
0.5	0.87	8.73
0.6	1.05	10.47
0.7	1.22	12.22
0.8	1.40	13.96
0.9	1.57	15.71
1.0	1.74	17.45

Bold = within recommended limits for V-belt drives

Note that the values between 0.1 and 0.5 fall within recommended misalignment limits for V-belt drives.

Gates EZ Align™ 7420-3000 TECHNICAL DATA

EZ ALIGN™ GREEN LASER TRANSMITTER

Operating Distance:	15 Ft. or Better
Accuracy:	1/16" at 6 Ft. (1.6mm at 1.9m)
Laser Type:	532nm Visible Green Laser Diode
Laser Power:	<1 mW, Class II
Laser Line Length:	28" at 6 Ft. (711mm at 1.9m)
Controls:	Laser ON/OFF/ON Flashlight Rocker Switch
Operating Time:	25 Hours Continuous at 72 °F
Battery Type:	2 AAA Alkaline Batteries
Operating Temp:	15 °F (9 °C) to 110 °F (43 °C)
Storage Temp:	-4 °F (-20 °C) to 140 °F (60 °C)
Mounting:	Magnetic
Weight:	17.0 oz. (483 g)
Dimensions:	1.3" (33mm) W x 1.3" (33mm) D x 8" (203mm) H
Housing:	Aluminum, Powder Coat Finish

EZ ALIGN™ GREEN REFLECTOR

Reflector Size:	1" (25mm) W x 1.4" (36mm) H
Mounting:	Magnetic
Weight:	9.4 Oz. (266 g)
Dimensions:	1.3" (33mm) W x .9" (23mm) D x 8" (203mm) H
Housing:	Aluminum, Powder Coat Finish

CARRYING CASE

Material:	Black, High Density Polyethylene
Dimensions:	10.25" (260mm) W x 8" (203mm) D x 3" (76mm) H
Insert:	Die Cut Foam
Total Package Weight:	2.6 Lbs. (1.2 kg)

EZ ALIGN is a registered trademark of Gates Corporation

SEE MORE POWER TRANSMISSION SOLUTIONS AT GATES.COM/PT

© 2010 - 2018 Gates Corporation. All rights reserved.
17535-M-G 6/18



GATES.COM